



HV100 Series Frequency Inverter User Manual

HNC Electric Limited

Contents

Contents.....	1
Chapter I Safety Information.....	3
1.1 Marks and definitions of safety information	3
1.2 Use range	3
1.3 Installation Environment	3
1.4 Installation safety matters	4
1.5 Use safety matters	5
Chapter II Standard Specifications of Products.....	6
2.1 Technical specifications	6
2.2 Inverter model description	9
2.3 Size of chassis and keyboard	9
2.4 Rated current output meter	11
2.5 Selection of Braking Resistance Table	11
Chapter III Storage and Installation.....	13
3.1 Storage	13
3.2 Installation site and environment	13
3.3 Installation space and direction	13
Chapter IV Wiring.....	14
4.1 Main circuit wiring diagram	14
4.2 Connecting terminal Figure	14
4.2.1 The function description of the main circuit terminal is as follows:.....	14
4.2.2 The terminal for controlling loop.....	15
4.2.3 Jumper settings of main control board.....	16
4.3 Basic wiring diagram	16
4.4 Matters needing attention for Wiring	18
4.4.1 Main circuit wiring.....	17
4.4.2 Control circuit wiring (signal line).....	18
4.4.3 Grounding wire.....	19
4.5 Matters needing attention for specific application	18
4.5.1 Type selection.....	19
4.5.2 Matters needing attention in motor use.....	19
Chapter V Operation and display.....	20
5.1 keypad description.....	20
5.1.1 Diagram of keypad.....	20
5.1.2 Key Description.....	20
5.1.3 Description of function indicator lamp.....	20
5.2 Operation process	21
5.2.1 Parameter setting.....	21
5.2.2 Fault reset.....	21
5.2.3 Self-learning of motor parameters.....	21
Chapter VI Functions and Parameter Table.....	22
Chapter VIII EMC (Electromagnetic Compatibility).....	60
8.1 Definitions	129
8.2 Introduction to EMC Standards	126

HV100 Series High Performance Current Vector Inverter

8.3 EMC guidance	126
8.3.1 Influence of harmonics:.....	126
8.3.2 Electromagnetic interference and installation precautions:.....	126
8.3.3 Treatment method of interference of peripheral electromagnetic equipment.....	126
8.3.4 Measures to deal with interference caused by inverter to peripheral equipment:.....	126
8.3.5 Leakage current and treatment:.....	127
8.3.6 Precautions for installing EMC input filter at power input end:.....	130
Chapter IX Fault Diagnosis and Countermeasures.....	128
9.1 Fault Alarm and Countermeasures	128
9.2 Exception handling	130
Appendix 1: Modbus communication protocol.....	131
Appendix 2: Description of macro parameter setting.....	144
Appendix 3: Parameter description of soft start water supply of three pump circulation.....	144
Warranty agreement.....	146

Chapter I Safety Information

1.1 Marks and definitions of safety information

The safety clauses described in this User's manual are very important, which can ensure you to use the inverter safely, and prevent yourself or the people around you from being hurt and the property in the working area from being damaged. Please be fully familiar with the following icons and meanings, and be sure to observe the precautions indicated, and then continue to read this user's manual.



Danger

This symbol indicates that failure to operate as required may cause death or serious injury.



Warning

This symbol indicates that if you do not operate as required, it will cause moderate personal injury or minor injury and certain material loss.



Attention

This symbol indicates matters needing attention in operation or use.



Prompt

This symbol prompts the user with some useful information.

The following two icons are supplementary descriptions of the above signs:



Prohibition

It means something that must not be done.



Enforcement

Indicates something that must be done.

1.2. Use range



Attention

This inverter is suitable for general industrial three-phase AC asynchronous motors.



Warning

- And in equipment (nuclear power control equipment, aerospace equipment, transportation equipment, life support system, safety equipment, weapon system, etc.) which may threaten life or harm human body due to inverter failure or working error, please consult our company in advance for special purpose.
- This product is manufactured under the strict supervision of the quality management system, but safety protection measures must be taken to prevent the inverter from expanding the scope of the accident when it is used in important equipment.

1.3 Installation Environment

- is installed indoors and in well-ventilated places, and should be installed vertically to ensure the best cooling effect. additional ventilation devices may be required in horizontal installation.
- The environmental temperature should be within the range of -10 ~ 40°C. If the temperature exceeds 40°C, please remove the upper cover. If the temperature exceeds 50°C, it needs external forced heat dissipation or derating. Users are advised not to use the inverter in such a high temperature environment, because this will greatly reduce the service life of the inverter.

HV100 Series High Performance Current Vector Inverter

- The environmental humidity is required to be lower than 90%, and there is no condensation of water droplets.
- It is installed in a place with vibration less than 0.5G to prevent falling damage. The inverter is not allowed to suffer sudden impact.
- It is installed in an environment far away from electromagnetic fields and free of inflammable and explosive substances.

1.4 Installation safety matters



- Do not work with wet hands.
- It is strictly forbidden to carry out wiring operations without completely disconnecting the power supply.
- When the inverter is powered on, please do not open the cover or carry out wiring operation, otherwise there is a danger of electric shock.
- When wiring and inspection are carried out, it must be carried out 10 minutes after the power supply is turned off, otherwise there is a danger of electric shock.



- Do not install inverters with damaged or missing components to avoid personal accidents and property losses.
- The main circuit terminal must be firmly connected with the cable, otherwise the inverter may be damaged due to poor contact.
- For the sake of safety, the grounding terminals of inverters must be grounded reliably. To avoid the influence of grounding common impedance interference, multiple inverters should be grounded by one-point grounding, as shown in Figure 1-1.

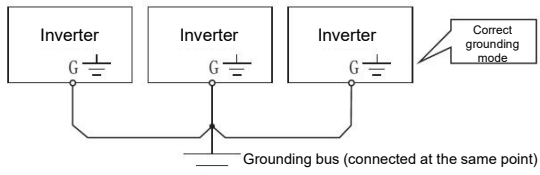
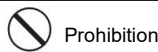

Figure 1-1



- It is forbidden to connect the AC power supply to the output terminals U, V and W of the inverter, otherwise the inverter will be damaged, as shown in Figure 1-2.

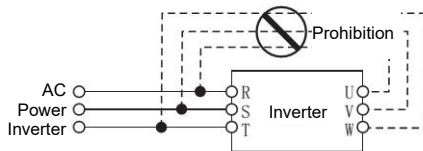
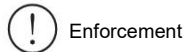

Figure 1-2



- When it is on the input power supply side of the inverter. Be sure to configure a fuse-free circuit breaker for circuit protection to prevent the accident from expanding due to the failure of the inverter.

HV100 Series High Performance Current Vector Inverter



Attention

• The electromagnetic contactor should not be installed on the output side of the inverter, because the contactor will turn on and off when the motor is running, which will produce operating overvoltage and cause damage to the inverter. However, configuration is still necessary for the following three situations:

The frequency conversion governor used for energy-saving control, the system often works at rated speed, and in order to realize economic operation, it is necessary to cut off the inverter.

Participate in important process flow, can't shut down for a long time, and need to switch between various control systems to improve system reliability.

When one inverter controls multiple motors. Users should pay attention to the fact that the contactor must not act when the inverter has output!

1.5 Use safety matters



Danger

• Do not operate with wet hands.
• For inverters with stored for more than one year, the voltage regulator should be used to gradually increase the voltage to the rated value when powering on, otherwise there is danger of electric shock and explosion.

• Don't touch the inside of the inverter after it is powered on, and don't put bars or other objects into the inverter, otherwise it will cause electric shock death or the inverter can't work normally.

• Please do not open the face cover when the inverter is powered on, otherwise there is a danger of electric shock.

• Use the restart function after power failure with caution, otherwise it may cause personal injury or death.



Warning

• If it runs over 50Hz, it is necessary to ensure the speed range of motor bearings and mechanical devices in use.

• Mechanical devices requiring lubrication, such as reduction boxes and gears, should not run at low speed for a long time, otherwise their service life will be shortened and even equipment will be damaged.

• When the ordinary motor runs at low frequency, it must be derated because of its poor heat dissipation effect. If it is a constant torque load, it must adopt the forced heat dissipation mode of motor or adopt a special frequency conversion motor.

• Please cut off the input power of the inverter when it is not used for a long time, so as to avoid the inverter being damaged or even causing fire due to foreign matter entering or other reasons.

• Since the output voltage of the inverter is PWM pulse wave, please do not install capacitors or surge current absorbers (such as piezoresistors) at its output end, otherwise the inverter will fail and trip, and even the power components will be damaged. If installed, be sure to remove it. As shown in figure 1-3.

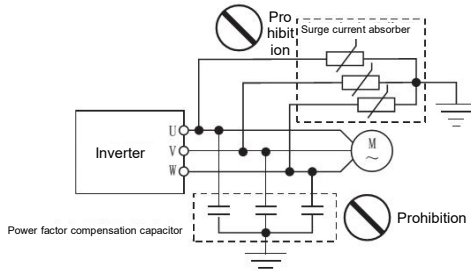

Figure 1-3



Attention

• Before the motor is used for the first time or placed for a long time before reuse, the motor insulation shall be checked and the measured insulation resistance shall be ensured to be no less than 5MΩ.

• If you need to use the inverter outside the allowable working voltage range, you need to configure a step-up or step-down device for transformation processing.

• In the area where the altitude exceeds 1,000 meters, the heat dissipation effect of the inverter will deteriorate due to the thin air, so it needs to be derated. Generally, it needs to be derated by about 10% for every 1000m increase.

Chapter II Standard Specifications of Products

2.1 Technical specifications

Input	Rating Voltage , Frequency	Three-phase (G3/G4 series) 380V-480V, 50/60Hz Single&Three-phase (G1/G2 series) 220 V: 50/60 Hz		
	Allowable range of voltage	Three-phase (G3 series) : AC 380~440 (-15%~+10%) Three-phase (G4 series) : AC 460~480 (-15%~+10%) Single&Three-phase (G1/G2 series) : AC220V ± 15%		
Output	Voltage	G1/G2 series; 0 ~ 220V, G3 series; 0 ~ 440 V, G4 series; 0 ~ 480 V		
	Frequency	Low frequency mode: 0 ~ 300 Hz; high frequency mode: 0 ~ 3000 Hz		
	Overload capacity	G type machine: 110% long-term; 150% 1 minute ;200% 4 seconds P type machine: 105% long-term ;120% 1 minute; 150% 1 second		
Control mode		V/F control, advanced V/F control, V/F separation control and PG-free current vector control		
Control characteristic	Frequency setting Resolution	Analog end input	0.1% of the maximum output frequency	
		Digital settings	0.01Hz	
	Frequency accuracy	Analog input	Within 0.2% of the maximum output frequency	
		Digital input	Set the output frequency within 0.01%	
	V/F control	V/F curve (voltage frequency characteristic)	The reference frequency can be set arbitrarily from 0.5 Hz to 3000 Hz, and the multi-point V/F curve can be set arbitrarily. You can also choose a variety of fixed curves such as constant torque, torque reduction 1, torque reduction 2 and square torque	
		Torque boost	Manual setting: 0.0 ~ 30.0% of rated output Automatic boost: automatically determine the boost torque according to the output current and motor parameters	
Automatic current and voltage limiting		Whether in acceleration, deceleration or stable operation, the motor stator current and voltage can be automatically detected, which can be suppressed within the allowable range according to the unique algorithm to minimize the possibility of system fault tripping		
Control characteristic	Sensorless vector control	voltage frequency characteristic	Automatically adjust output voltage-frequency ratio according to motor parameters and unique algorithm	
		Torque characteristic	Starting torque: 150% rated torque at 3.0Hz (VF control) 150% rated torque at 1.0Hz (advanced VF control) 150% rated torque at 0.5Hz (without PG current vector control) Running speed steady-state accuracy: $\leq \pm 0.2\%$ rated synchronous speed Speed fluctuation: $\leq \pm 0.5\%$ rated synchronous speed Torque response: $\leq 20\text{ms}$ (without PG current vector control)	
		Self-determination of motor parameters	Without any restriction, the parameters can be automatically detected under static and dynamic conditions to obtain the best control effect	
		Current and voltage suppression	Full-range current closed-loop control, completely avoiding current impact, with perfect overcurrent and overvoltage suppression function	
	Running undervoltage suppression	Especially for users with low grid voltage and frequent fluctuation of grid voltage, the system can maintain the longest possible operation time according to the unique algorithm and residual energy allocation strategy even in the range below the allowable voltage		
Typical function	Multi speed and Swing frequency operation	16-stage programmable multi-stage speed control and multiple operation modes are optional. Swing frequency operation: preset frequency and center frequency can be adjusted, and state memory and recovery after power failure		
	PID control RS485 communication	Built-in PID controller (preset frequency). Standard configuration RS485 communication function, multiple communication protocols can be selected, with linkage synchronous control function		
	Frequency setting	Analog input	DC voltage 0 ~ 10 V, DC current 0 ~ 20 mA (upper and lower limits are optional)	
		Digital input	keypad setting, RS485 interface setting, UP/DOWN terminal control, and various combination settings with analog input can also be made.	
Output signal	Digital output	2 Y-terminal open collector outputs and two programmable relay outputs (TA/TB/TC), with up to 61 functions		

HV100 Series High Performance Current Vector Inverter

		Analog output	2 analog signals are output, and the output range can be flexibly set between 0 ~ 20mA or 0 ~ 10V, which can realize the output of physical quantities such as set frequency and output frequency
	Automatic voltage stabilizing operation		According to the needs, three modes can be selected: dynamic voltage stabilization, static voltage stabilization and non-voltage stabilization, so as to obtain the most stable operation effect
	Acceleration and deceleration Time setting		0.1s ~ 3600.0min can be set continuously, and S-type and linear mode can be selected
Brake	Energy consumption Brake		Energy consumption braking starting voltage, return difference voltage and energy consumption braking rate can be continuously adjusted
	Direct current Brake		Starting frequency of DC braking during shutdown: 0.00 ~ [00.13] upper limit frequency Braking time: 0.0 ~ 100.0 s; Braking current: 0.0% ~ 150.0% rated current
	Magnetic flow Brake		0 ~ 100 0: invalid
	Low noise operation		The carrier frequency is continuously adjustable from 1.0 kHz to 16.0 kHz to minimize the noise of the motor
	Revolving speed tracking speed Restart facility		It can realize the smooth restart and instantaneous stop restart of the motor in operation
	Counter		One internal counter is convenient for system integration
	Operating function		Upper and lower limit frequency setting, frequency jump operation, reverse operation limit, slip frequency compensation, RS485 communication, frequency increment and decrement control, fault self-recovery operation, etc
Display	keypad display	Running State	Output frequency, output current, output voltage, motor speed, set frequency, module temperature, PID setting, feedback amount, analog input and output, etc
		Alarm Content	The last six fault records, the record of six operation parameters such as output frequency, set frequency, output current, output voltage, DC voltage and module temperature during the last fault trip.
Protection function			Over-current, over-voltage, under-voltage, module failure, electronic thermal relay, overheating, short circuit, input and output phase failure, abnormal tuning of motor parameters, internal memory failure, etc.
Environment	Ambient temperature		-10℃ ~ +40℃ (the ambient temperature is 40℃ ~ 50℃, please use it at a reduced level)
	Ambient humidity		5% ~ 95% RH, no water condensation
	Surrounding environment		Indoor (no direct sunlight, corrosion, flammable gas, oil mist, dust, etc.)
	Altitude		1000 meters above the use of derating, every 1000 meters up derating 10%
Structure	Protection grade		IP20
	Cooling mode		Air-cooled with fan control
Installation method			Wall mounted, cabinet mounted

2.2 Inverter model description

2.2.1 Product naming

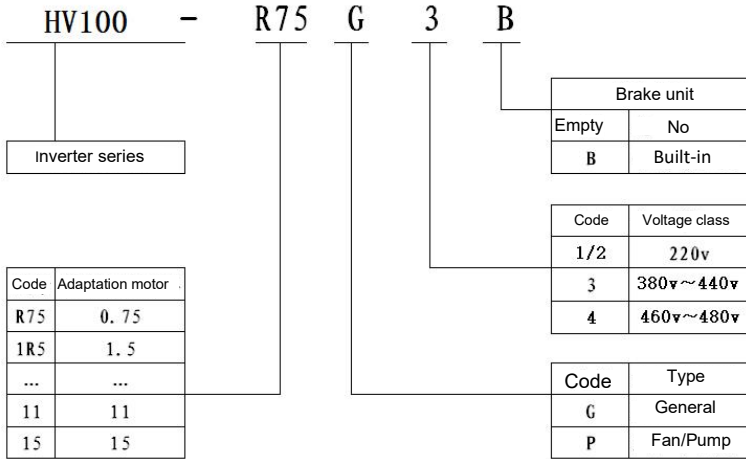

Figure 2-1 Naming Rules

2.2.2 Nameplate marking

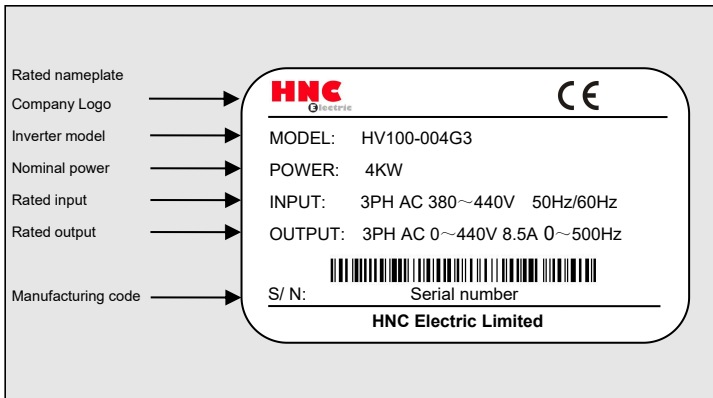

Figure 2-2 nameplate

2.3 Size of inverter and keyboard

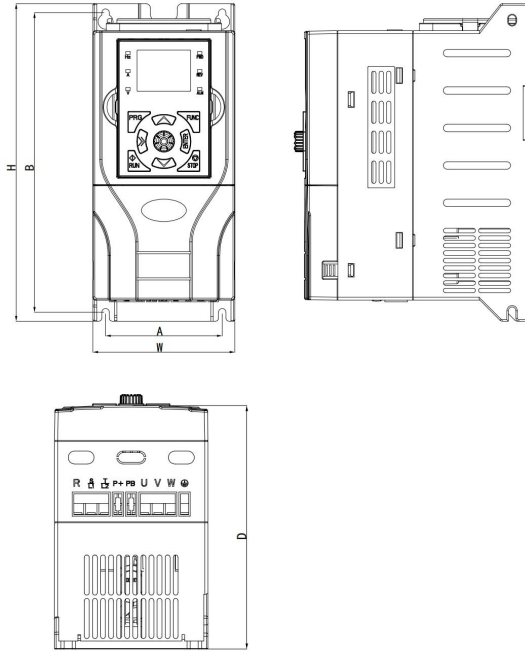
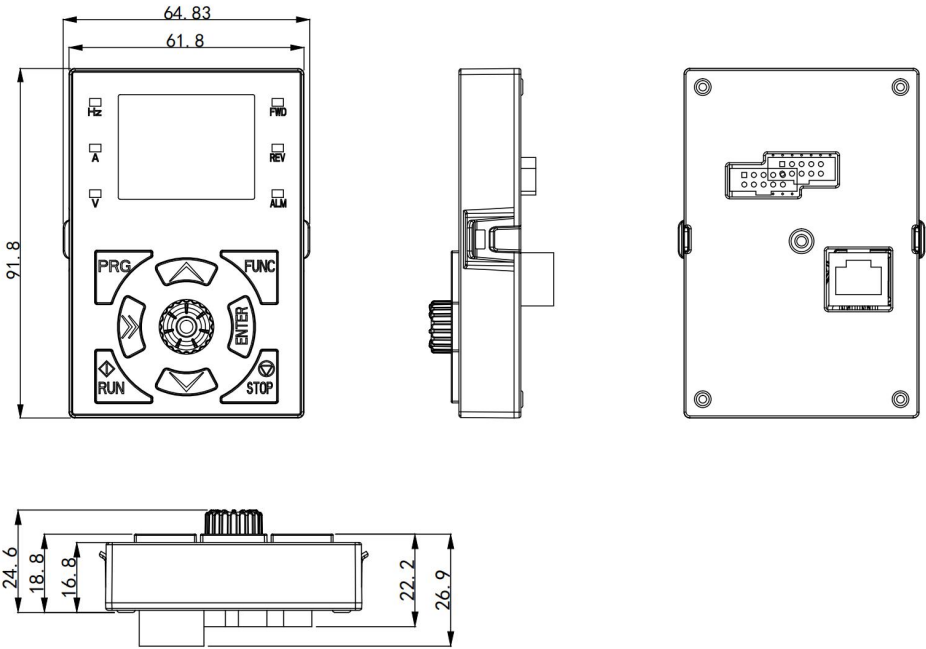

Figure 2-3 Dimensions of Inverter 0.75KW~30KW

Model No.		A (mm)	B (mm)	H (mm)	W (mm)	D (mm)	Installation hole (mm)
		Mounting dimension		Exterior dimensions			
Single phase AC220V	0.4KW-2.2KW	78	200	212	95	154	5
	4KW-5.5KW	129	230	240	140	180.5	5
Three phase AC220V	7.5KW-15KW	188	305	322	205	199	6
	0.75KW-4KW	78	200	212	95	154	5
Three phase AC380 ~480V	5.5KW-11KW	129	230	240	140	180.5	5
	15KW-30KW	188	305	322	205	199	6

Keyboard dimensions:



2.4 Rated current output table

Voltage	Single - phase	Three-phase	
	220V	220V	380~480V
Power(KW)	Current (A)	Current (A)	Current (A)
0.4	2.3	2.1	-
0.75	4	3.8	2.1
1.5	7	7.2	3.8
2.2	9.6	9	5.1
4	-	13	9
5.5	-	25	13
7.5	-	32	17
11	-	45	25
15	-	60	32
18.5	-	-	37
22	-	-	45
30	-	-	60

2.5 Selection of Braking Resistance Table

Voltage(V)	Inverter power (KW)	Brake resistance specification		Braking torque
		W	Ohm	10%ED
Single-phase 220 series	0.4	80	200	125
	0.75	80	150	125
	1.5	100	100	125
	2.2	100	70	125
Three-phase 220 series	0.4	90	300	125
	0.75	150	110	125
	1.5	250	100	125
	2.2	300	65	125
	4	400	45	125
	5.5	800	22	125
	7.5	1000	16	125
	11	2300	12	125
Three-phase 380~480 series	0.75	140	750	125
	1.5	300	400	125
	2.2	400	250	125
	4	750	150	125
	5.5	1100	100	125
	7.5	1500	75	125
	11	2200	50	125
	15	3000	38	125
	18.5	4000	32	125
	22	4500	27	125
30	6000	20	125	

HV100 Series High Performance Current Vector Inverter

Notes:

1. Please select the resistance value specified by our company.
2. Our company will not be liable for any damage to the inverter or other equipment caused by the use of brake resistors other than those provided by our company.
3. The safety and flammability of the environment must be considered in the installation of the brake resistor, and the distance from the inverter should be at least 100 mm.
4. The parameters in the table are for reference only, not as standards.

Chapter III Storage and Installation

3.1 storage

This product must be placed in a packing box before installation. If it is not used temporarily, please pay attention to the following items when storing:

- It must be placed in a dry place without dirt;
- The storage environment temperature is within the range of -20°C to $+65^{\circ}\text{C}$;
- The relative humidity of the storage environment is in the range of 0% to 95%, and there is no condensation;
- The storage environment contains no corrosive gas or liquid;
- It is best to be placed on a shelf and packaged for storage. It is best not to store the inverter for a long time.

Long-term storage will lead to deterioration of electrolytic capacitor. If long-term storage is required, it must be ensured that it is electrified once within half a year for at least 5 hours. When inputting, the voltage must be slowly increased to the rated voltage value by a voltage regulator.

3.2 Installation site and environment

Note: the environmental conditions of the installation site will affect the service life of the inverter. Please install the inverter in the following places:

- Ambient temperature: $-5 \sim 40^{\circ}\text{C}$ and good ventilation;
- Places without dripping water and low temperature;
- Places without sunlight, high temperature and serious dust falling;
- Places without corrosive gases and liquids;
- Places with less dust, oil and gas and metal dust;
- Places without vibration and easy to maintain and check;
- Places without electromagnetic noise interference;

3.3 Installation space and direction

- For the convenience of maintenance, enough space should be left around the inverter. As shown in the figure.
- In order to achieve good cooling effect, the inverter must be installed vertically and the air circulation should be smooth.
- If the installation is not secure. After installing a flat plate under the base of the inverter, it is installed on a loose plane, and the stress may cause damage to the main circuit parts, thus damaging the inverter;
 - The wall of installation shall be made of incombustible materials such as iron plates.
 - Multiple inverters are installed in the same cabinet. When installing from top to bottom, pay attention to the spacing, and add a diversion baffle in the middle or install it in a staggered way.

Chapter IV Wiring

4.1 Main circuit wiring diagram



Power supply: Please pay attention to whether the voltage levels are consistent, so as not to damage the inverter.



Fuseless switch: please refer to the corresponding table.
Leakage switch: please use leakage switch with high-order harmonic protection.



Magnetic contactor:
Note: please do not use electromagnetic contactor as the power switch of frequency converter.



Ac reactor: when the output capacity is greater than 1000KVA, it is recommended to install an AC reactor to improve the power factor.



Inverter:
Be sure to properly connect the main circuit and control signal line of the inverter.
Be sure to set the inverter parameters correctly.

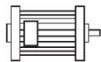

4.2 Connecting terminal Figure

4.2.1 The function description of the main circuit terminal is as follows:

Terminal name	Function description
R、S、T	Three-phase power input Terminal
P+、P-	External brake unit reserved terminal
P+、PB	External braking resistor reserved terminal (0.75KW~30.0KW)
P+、P1	Reserved terminal of external DC reactor
U、V、W	Three-phase AC output terminal
	Ground terminal

4.2.2 The terminal for controlling loop

+10V	GND	485+	485-	DI1	DI3	DI5	DI7	Y1	DO	TA2	TB2	TC2
A11	A12	AO1	COM	DI2	DI4	DI6	COM	OP	24V	TA1	TB1	TC1

Function description of control circuit terminal

Classification	Terminal label	Description of functions	Specification
Multifunctional digital input terminal	DI1	Short circuit between DI(DI1, DI2, DI3, DI4, DI5, DI6, HDI) ~ COM is valid, and its functions are set by parameters 07.00 ~ 07.06 respectively (common terminal: com).	Input, 0 ~ 24V level signal, active at low level, 5mA.
	DI2		
	DI3		
	DI4		
	DI5		
	DI6		
	DI7(HDI)	HDI can be used as a common multi-function terminal, and can also be programmed as a high-speed pulse input port. see 07.06 functional description for details.	
Analog input and output terminals	A11	A11 receives analog voltage/current input. The voltage and current are selected by jumper JP3. The factory default input voltage. If the current is to be input, just adjust the jumper cap to Cin position. A12 only receives voltage input. See the description of function code 06.01 ~ 06.10 for the setting of measuring range. (reference ground: GND)	INPUT, input voltage range: 0 ~ 10v (input impedance: 100KΩ), input current range: 0 ~ 20ma (input impedance: 500Ω).
	A12		
	AO1	AO1 provides analog voltage/current output, which can represent 14 physical quantities. The output voltage and current are selected by jumper JP4, and the factory default output voltage. If you want to output current, just jump the jumper cap to Co1 position. See description of function codes 06.21 and 06.22 for details. (reference ground: GND)	
	AO2 (Reserved)		
Relay output terminal	TA1	Programmable relay output terminals are defined as multi-functions, with 62 types. See 07.20 and 07.21 for details.	TA1-TB1 and TA2-TB2 are normally closed; TA1-TC1 and TA2-TC2 are normally open. Contact capacity: 250vac/2a (cos φ = 1); 250VAC/1A(COSφ=0.4),30VDC/1 A.
	TB1		
	TC1		
	TA2		
	TB2		
	TC2		
Open Collector output terminal	HDO	Programmable defined as multifunctional collector output terminals, up to 62 kinds. See 07.18 and 07.19 for details.	1. Switching capacity: 50mA/30V 2. Output frequency range: 0~50kHz
	Y1		1. Switching capacity: 50mA/30V 2. Output frequency range: 0~1kHz

HV100 Series High Performance Current Vector Inverter

DC power supply	+24V	+24V is the circuit common power supply of digital signal input terminal	Maximum output current 200mA
	+10V	+10V is the circuit common power supply of analog input and output terminals	Maximum output current 20mA
	OP	The factory default is OP connected to +24V. When using external signals to drive DI1~DI6, OP needs to be connected to the external power supply and disconnected from the +24V power supply terminal	External power input terminal
	COM	Digital signal and +24V power supply reference ground	Internally isolated from GND
	GND	Analog signal and +10V power supply reference ground	Isolated internally from COM
Communication interface	485+	RS485+	Standard RS485 communication interface is not isolated from GND. Please use twisted pair or shielded wire.
	485-	RS485-	

4.2.3 Jumper settings of main control board

JP2	
OFF	Represents 485 communication terminal resistance is not connected
ON	Represents 485 communication terminal resistance is connected
JP3	
Cin	Represents AI1 input current signal, 4-20mA
Vin	Represents AI1 input voltage signal, 0-10V
JP4	
Vo1	Represents AO1 output voltage signal, 0-10V
Co1	Represents AO1 output current signal, 4-20mA
JP5	
Vo2(Reserved)	Represents AO2 output voltage signal, 0-10V
Co2(Reserved)	Represents AO2 output current signal, 4-20mA

4.3 Basic wiring diagram

Inverter wiring is divided into main circuit and control circuit. The user can lift the cover of the shell, and the main circuit terminal and the control circuit terminal can be seen at this time. The user must connect accurately according to the following wiring circuits.

HV100 Series High Performance Current Vector Inverter

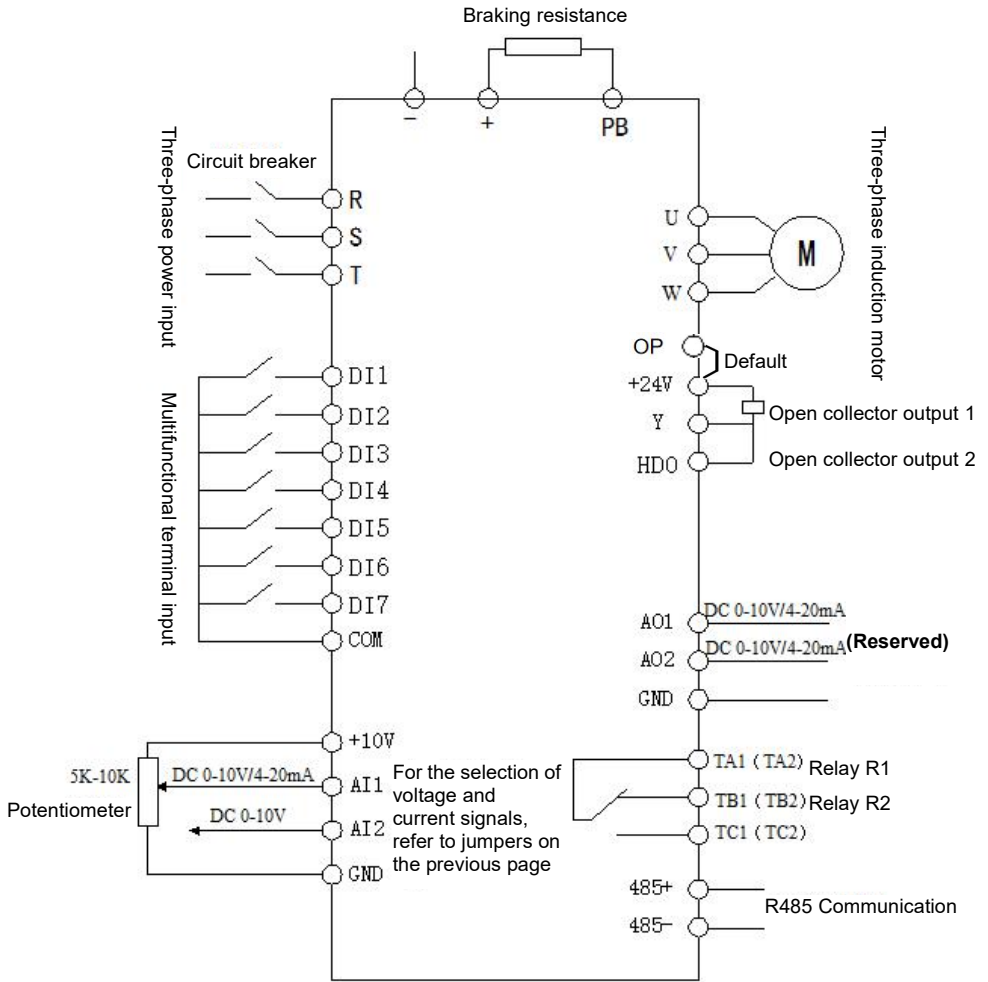

Basic operation wiring diagram

4.4 Matters needing attention for Wiring

4.4.1 Main circuit wiring

- When wiring, please implement wiring in accordance with the provisions of electrical laws and regulations to ensure safety.
- For power supply wiring, please use isolation wire or line pipe, and ground both ends of the isolation layer or line pipe;
- Please install an air circuit breaker NPB between the power supply and the input terminals (R, S, T). (If using the leakage circuit breaker, please use the circuit breaker with high frequency countermeasures).
- Please arrange the power line and control line separately, and do not place them in the same trunking.
- Do not connect the AC power supply to the inverter output terminals (U, V, W);
- The output wiring must not touch the metal part of the inverter housing, otherwise it may cause a short circuit to the ground.
- Components such as phase-shifting capacitors, LC and RC noise filters cannot be used at the output end of inverter.
- The main circuit wiring of inverter must be far away from other control equipment.

HV100 Series High Performance Current Vector Inverter

- When the wiring between the inverter and the motor exceeds 50m (220V series) and 100m (380V class), high dv/dt will be generated in the coil of the motor, which will damage the interlayer insulation of the motor. Please use the AC motor dedicated to the inverter or install a reactor on the inverter side.

- When the distance between the inverter and the motor is long, please reduce the carrier frequency, because the larger the carrier, the greater the leakage current of higher harmonic on the cable, which will have adverse effects on the inverter and other equipment.

4.4.2 Control circuit wiring (signal line)

The signal line should not be placed in the same slot as the main circuit wiring, otherwise interference may occur. Please use shielded wires for signal wires, and ground them at one end. The wire diameter is 0.5-2mm². 1 shielded wire is recommended for the control line. Use the control terminals on the control keypad correctly as required.

4.4.3 Grounding wire

Please use the third grounding method (below 100Ω) to ground the grounding wire terminal E; Please use the grounding wire according to the technical basic length and size of electrical equipment; Never share the grounding electrode with large power equipment such as electric welding machine and power machinery, and the grounding wire should be as far away from the power line of large power equipment as possible; Please use the grounding wiring mode of multiple inverters in the following figure (a) to avoid the loop of (b) or (c).

- Grounding wiring must be as short as possible.

- Please properly ground the grounding terminal E, and never connect to the zero line.

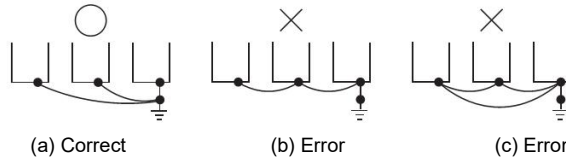

4.5 Matters needing attention for specific application

4.5.1 Type selection

(1) Installation of reactor

When the inverter is connected to a large-capacity power transformer (above 600kVA) or the phase-advancing capacitor is switched, the power input circuit will produce excessive peak current, which may damage the components of the converter. To prevent this, please install DC reactor or AC reactor. This also helps to improve the power factor on the power supply side. In addition, when thyristor converters such as DC drivers are connected to the same power supply system, DC reactors or AC reactors must be set regardless of power supply conditions.

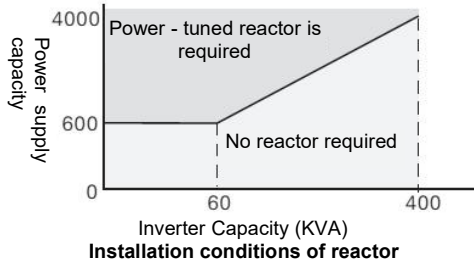

(2) Inverter capacity

When running a special motor, please make sure that the rated current of the motor is not higher than the rated output current of the inverter. In addition, when running multiple induction motors in parallel with a inverter, the capacity of the inverter should be selected so that 1.1 times of the total rated current of the motors is less than the rated output current of the inverter.

(3) Starting torque

The starting and accelerating characteristics of the motor driven by inverter are limited by the overload rated current of the combined inverter. Compared with the starting of general commercial power supply, the torque characteristic is smaller. If a large starting torque is required, please increase the capacity of the inverter by one level or increase the capacity of the motor and inverter at the same time.

(4) Emergency stop

Although the protection function will act and the output will stop when the inverter fails, the motor cannot be stopped suddenly at this time. Therefore, please set mechanical stop and hold structure on the mechanical equipment that needs emergency stop.

HV100 Series High Performance Current Vector Inverter

(5) Special options

Terminals PB(+) and P1(+) are terminals for connecting with special optional items. Do not connect machines other than special options.

(6) Precautions related to reciprocating load

When the inverter is used for reciprocating loads (cranes, elevators, punching machines, washing machines, etc.), if 150% or more of the current flows repeatedly, the service life of IGBT inside the inverter will be shortened due to thermal fatigue. As a general standard, when the carrier frequency is 4kHz and the peak current is 150%, the starting/stopping times are about 8 million times.

Especially when low noise is not required, please reduce the carrier frequency. In addition, please reduce the peak current during reciprocating to less than 150% by reducing the load, prolonging the acceleration and deceleration time, or increasing the capacity of the inverter by one level (during the trial run for these purposes, please confirm the peak current during reciprocating and adjust it as needed). In addition, when used in cranes, it is suggested to make the following choices to ensure the motor torque and reduce the current of the inverter, because the starting/stopping action during JOG is fast. The capacity of the inverter should ensure that its peak current is lower than 150%. The capacity of inverter should be more than 1 level larger than that of motor.

4.5.2 Matters needing attention in motor use

(1) It is used for existing standard motors

Low speed domain

Compared with the standard motor driven by commercial power supply, the loss caused by using inverter will increase somewhat. In the low speed range, the cooling effect will deteriorate and the temperature of the motor will increase. Therefore, in the low speed range, please reduce the load torque of motor. The allowable load characteristics of our standard motor are shown in the figure. In addition, when 100% continuous torque is required in low speed range, please discuss whether to use the special motor for inverter.

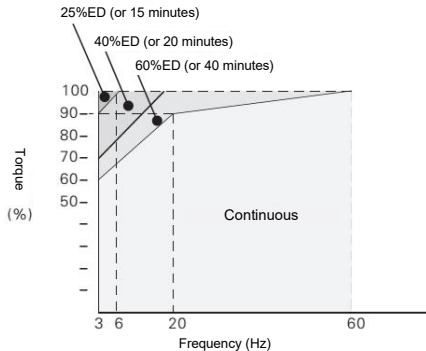

Allowable load characteristics of our standard motor

(2) Matters needing attention for special motors

The rated current of the pole-changing motor is different from that of the standard motor. Please confirm the maximum current of the motor and select the corresponding inverter. Be sure to switch the number of poles after the motor stops. If switching is performed during rotation, the regeneration overvoltage or overcurrent protection circuit will act and the free running of the motor will stop.

Motor with brake

When using inverter to drive motor with brake, if the brake circuit is directly connected to the output side of inverter, the brake will not open due to the low voltage during starting. Please use the motor with brake with independent brake power supply, and connect the brake power supply to the power supply side of the inverter. In general, when using a motor with a brake, the noise in the low speed range may become larger.

(3) Power transmission structure (reducer, belt, chain, etc.)

When the gearbox, gearbox and reducer with oil lubrication mode are used in the power transmission system, the oil lubrication effect will become worse if they only run continuously in the low speed range, so please pay attention. In addition, when running at high speed above 60Hz, problems such as noise of power transmission structure, service life, strength caused by centrifugal force, etc. will occur, so please pay full attention to it.

Chapter V Operation and display

5.1 keypad description

5.1.1 Diagram of keypad

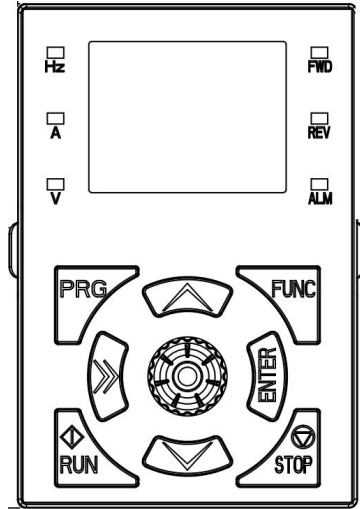

5.1.2 Key Description

Key symbol	Name	Functional Description
PRG	Programming key	Menu entry or exit, parameter modification
ENTER	Confirm key	Enter the menu and confirm the parameter setting
▲	Incremental key	Increment of data or function code
▼	Decreasing key	Decrement of data or function code
▶▶	Shift key	Select parameter modification bit and display content
RUN	Operation key	Operation under keyboard operation mode
STOP	Stop key	Stop operation
FUNC	Multifunctional keys	Select according to function toggle

5.1.3 Description of function indicator lamp

Indication lamp name	Description
REV	Inverter reverse indicator lamp, which indicates reverse operation state when it is on.
FWD	Inverter forward rotation indicator lamp, when the lamp is on, it indicates forward operation status.
ALM	Fault indicator light, which indicates that it is in a fault state.
Hz	Frequency unit
A	Current unit
V	Voltage unit

5.1.4 Description of the combination of function indicator lights:

Combination of indicator lights	LED display meaning	Symbol
Hz+A	Revolving speed of motor	r/min
A+V	Time (seconds)	s
Hz+V	Actual value of percentage	%
Hz+A+V	Temperature	°C

5.2 Operation process

5.2.1 Parameter setting

The three-level menus are:

1. Function code group number (level 1 menu);
2. Function code label (secondary menu);
3. Set value of function code (Level 3 menu).

Note: When operating the third-level menu, press PRG or ENTER to return to the second-level menu. The difference between them is: press ENTER to store the set parameters in the control keypad, then return to the secondary menu and automatically transfer to the next function code; Press PRG to directly return to the secondary menu, without storing parameters, and keep staying at the current function code.

In the third-level menu state, if the parameter has no blinking bit, it means that the function code cannot be modified. Possible reasons are:

- 1) The function code is an unmodified parameter. Such as actual detection parameters, operation record parameters, etc.
- 2) The function code cannot be modified in running state, and can only be modified after shutdown.

5.2.2 Fault reset

After the inverter fails, the inverter will prompt relevant fault information. The user can reset the fault through the STOP/RESET key on the keyboard or the terminal function. After the fault is reset, the inverter is in standby mode. If the inverter is in a fault state and the user does not reset the fault, the inverter is in a running protection state and the inverter cannot run.

5.2.3 Self-learning of motor parameters

Choose the vector control operation mode, before the inverter runs, the nameplate parameters of the motor must be accurately input, and the inverter matches the standard motor parameters according to the nameplate parameters; The vector control mode is highly dependent on the motor parameters, and accurate parameters of the controlled motor must be obtained in order to obtain good control performance.

Chapter VI Functions and Parameter Table

Symbols in the menu are described as follows

- ×: Parameters that can be modified in any state
- : Non modifiable parameters in operation state
- ◆: Actual test parameter, cannot be modified
- ◇: The manufacturer' parameters can only be modified by the manufacturer, but not by the user.

000 group-Basic Parameters					
Function code	Name	Content	Setting range	Factory	Alteration
00.00	LCD language (only valid for LCD keypad)	0: Chinese 1: English	0~1	0	○
00.01	Functional macro definition	0: General model 1: Single pump constant pressure water supply mode 2: One inverter with two power (1 variable frequency pump +2 power frequency pumps) water supply mode 3: Three-pump cycle soft start (3 variable frequency pumps) water supply mode 4: Solar pump water supply mode 5: CNC machine tool control mode 6: Fire patrol mode 7: EPS power mode 8~20:Reserved Note: Please initialize parameters before setting macro functions.	0~20	0	×
00.02	Control Mode	0: Common V/F Control (manual torque boost) 1: Advanced V/F Control (Automatic torque boost) 2: SVC mode (SVC) 3: Reserved 4: Separatable V/F Control Note: this parameter cannot be initialized, please modify it manually	0~4	Type setting	×
00.03	Run command channel selection	0: The keypad runs the command channel 1: Terminal operation command channel 2: Communication operation command channel	0~2	0	○

HV100 Series High Performance Current Vector Inverter

00.04	Selection of main frequency source A	<p>0: Digital setting 1(press keyboard key▲/▼, encoder +00.10) 1: Digital setting 2(UP/DOWN terminals +00.10) 2: Digital setting 3(Communication setting) 3: AI1 analog setting (0~10V/20mA) 4: AI2 analog setting (0~10V) 5: Pulse setting (0~50KHZ) 6: Simple PLC 7: Multi-speed setting 8: PID control 9: Keyboard potentiometer (Compatible encoder) 10:MPPT given (solar water pump) 11: Keyboard potentiometer</p>	0~11	9	○
00.05	Selection of auxiliary frequency source B	<p>0: Digital setting 1(press keyboard key▲/▼, encoder +00.10) 1: Digital setting 2(UP/DOWN terminals +00.10) 2: Digital setting 3(Communication setting) 3: AI1 analog setting (0~10V/20mA) 4: AI2 analog setting (0~10V) 5: Pulse setting (0~50KHZ) 6: Simple PLC 7: Multi-speed setting 8: PID control 9: Keyboard potentiometer (Compatible encoder) 10:MPPT given (solar water pump) 11: Keyboard potentiometer</p>	0~11	3	○
00.06	Frequency source given way	<p>0: Main frequency source A 1: A+K*B 2: A-K*B 3: A-K*B 4: MAX (A, K*B) 5: MIN (A, K*B) 6: Switch from A to K*B(A takes precedence over K*B) 7: Switch from A to (A+K*B)(A takes precedence over A+K*B) 8: Switch from A to (A-K*B)(A takes precedence over A-K*B) Note 1: Frequency switching needs to be realized through terminal cooperation Note 2: Compared with the given mode of this frequency source, frequency swing control has higher priority.</p>	0~8	0	○
00.07	Digital setting1	<p>LED single digit: power down store 0: store 1: not store LED 10-digit: stop keep 0: keep 1: stop not keep</p>	000~111	000	○
00.08	Digital setting2	<p>LED 100-digit: ▲/▼key、UF/DOWN negative frequency regulation 0: invalid 1: valid LED 1000-digit: Reserved</p>		000	○
00.09	Frequency source digital given 1 setting	This set value is the initial value of frequency digital given 1	0.00Hz~ 【00.13】	50.00	○

HV100 Series High Performance Current Vector Inverter

00.10	Frequency source digital given 2 setting	This set value is the initial value of frequency digital given 2	0.00Hz~ 【00.13】	50.00	○
00.11	Setting of auxiliary frequency source weight coefficient K	K is the weight coefficient of auxiliary frequency source	0.01~10.00	1.00	○
00.12	Max output frequency	The maximum output frequency is the highest frequency allowed by the inverter, and it is the benchmark for setting the acceleration and deceleration time.	Low frequency band: MAX { 50.00, 【00.13】 } ~ 300.00 High frequency band: MAX { 50.0, 【00.13】 } ~ 300.0	50.00	×
00.13	Upper limit frequency	Operating frequency cannot exceed this frequency	【00.14】 ~ 【00.12】	50.00	×
00.14	Lower limit frequency	Operating frequency cannot be lower than this frequency	0.00Hz~ 【00.13】	0.00	×
00.15	Frequency output mode	LED single digit: High and lower frequency mode selection 0: Lower frequency mode(0.00~300.00Hz) 1: High frequency mode(0.0~300.0Hz) LED 10-digit: Acceleration and deceleration reference selection 0: Maximum output frequency 1: Target output frequency LED 100-digit: Reserved LED 1000-digit: Reserved Note: High frequency mode is only effective for VF control	00~11	00	×
00.16	Acceleration Time 1	Time required for inverter to accelerate from zero frequency to maximum output frequency	0.1 ~3600.0S 0.4 ~4.0KW 7.5S 5.5 ~30.0KW 15.0S 37~132KW 30.0S	Type setting	○
00.17	Deceleration Time 1	Time required for inverter to decelerate from maximum output frequency to zero frequency	160~630KW 60.0S	Type setting	○
00.18	Running direction setting	0: Forward direction 1: Reverse direction 2: Forbidden reverse operation Note: This function code setting is valid for running direction control of all running command channels	0~2	0	×
00.19	Carrier frequency setting	When silent operation is needed, the carrier frequency can be appropriately increased to meet the requirements, but increasing the carrier frequency will increase the calorific value of the inverter.	1.0~16.0KHz 0.4~4.0KW 6.0KHz 5.5~30KW 4.5KHz 37~132KW 3.0KHz 160~630KW 1.8KHz	Type setting	○

HV100 Series High Performance Current Vector Inverter

00.20	User password	0~65535 Note1: 0~9: No password protection Note2: Password is set successfully, waiting for 3 minutes to take effect Note3: Write protection is not valid for this parameter and cannot be initialized	0~65535	0	○
01group:Start-Stop Control Parameters					
Function code	Name	Content	Setting range	Factory	Alteration
01.00	Starting mode	0: Starting frequency starting 1: DC breaking+starting frequency starting 2: Speed tracking starting	0~2	0	×
01.01	Starting frequency		0.00~50.00Hz	1.00	○
01.02	Starting frequency Holding time		0.0~100.0s	0.0	○
01.03	Starting DC braking current		0.0~150.0% *Rated current	0.0%	○
01.04	Starting DC braking time		0.0~100.0s	0.0	○
01.05	Acceleration/Deceleration mode		0: Straight line Acceleration / Deceleration 1: S-Curve Acceleration / Deceleration	0~1	0
01.06	Time proportion at the beginning of S curve	Set Time proportion at the beginning of S curve	10.0~50.0%	20.0%	○
01.07	Time proportion at the end of S curve	Set Time proportion at the end of S curve	10.0~50.0%	20.0%	○
01.08	Stop mode	0: Deceleration to stop 1: Free stop	0~1	0	×
01.09	Start frequency of DC braking during stop		0.00~ 【00.13】 Upper limit frequency	0.00	○
01.10	Waiting time for DC braking during stop		0.0~100.0s	0.0	○
01.11	DC braking current		0.0~150.0%* Motor Rated current	0.0%	○

HV100 Series High Performance Current Vector Inverter

01.12	Time for DC braking during stop		0.0~100.0s	0.0	○
01.13	Acceleration Time 2	Set Acceleration Time 2	0.1~3600.0S 0.4~4.0KW 7.5S 5.5~30KW 15.0S 37~132KW 40.0S 160~630KW 60.0S	Type setting	○
01.14	Deceleration Time 2	Set Deceleration Time 2		Type setting	○
01.15	Acceleration Time 3	Set Acceleration Time 3		Type setting	○
01.16	Deceleration Time 3	Set Deceleration Time 3		Type setting	○
01.17	Acceleration Time 4	Set Acceleration Time 4		Type setting	○
01.18	Deceleration Time 4	Set Deceleration Time 4		Type setting	○
01.19	Selection of acceleration and deceleration time unit	0: second 1: minute 2: 0.1second	0~2	0	○
01.20	Jog forward running frequency setting	Set Jog forward running / reverse operation frequency setting	0.00~ 【00.13】	5.00	○
01.21	Jog reverse running frequency setting		0.00~ 【00.13】	5.00	○
01.22	Jog Acceleration time	Set Jog Acceleration time	0.1~3600.0S 0.4~4.0KW 7.5S 5.5~30.0KW 15.0S 37~132KW 40.0S 160~630KW 60.0S	Type setting	○
01.23	Jog Deceleration time	Set Jog Deceleration time		Type setting	○
01.24	Jog Interval time setting	Set Jog Interval time setting	0.0~100.0s	0.1	○
01.25	Jump frequency 1		0.00~Upper limit frequency	0.00	○
01.26	Jump frequency 1 range		0.00~Upper limit frequency	0.00	○
01.27	Jump frequency 2		0.00~Upper limit frequency	0.00	○
01.28	Jump frequency 2 range		0.00~Upper limit frequency	0.00	○
01.29	Jump frequency 3		0.00~Upper limit frequency	0.00	○
01.30	Jump frequency 3 range		0.00~Upper limit frequency	0.00	○
01.31	Action when the set frequency is lower than the lower limit frequency	0: Run at the lower limit frequency. 1: zero frequency operation after delay time (there is no delay when starting). 2: Shutdown after a delay time (there is no delay when starting).	0~2	0	×

HV100 Series High Performance Current Vector Inverter

01.32	Stop delay time when frequency is lower than lower limit frequency (Simple dormancy)	Set stop delay time when frequency is lower than lower limit frequency (Simple dormancy)	0.0~3600.0s	10.0	○
01.33	Zero frequency braking current	This parameter is the percentage of the rated current of the motor.	0.0~150.0%*Rated current	0.0	×
01.34	Forward and reverse dead zone time	The waiting time for a inverter to transition from forward operation to reverse operation, or from reverse operation to forward operation.	0.0~100.0s	0.0	○
01.35	Forward and reverse switching mode	0: Over 0Hz frequency switching 1: Over start frequency switching	0~1	0	×
01.36	Emergency stop standby deceleration time	It is only valid for function No.10 in digital input terminal (07.00 ~ 07.06).	0.1~3600.0s	1.0	○
01.37	Current holding time for DC braking during shutdown	Set Current holding time for DC braking during shutdown	0.0~100.0s	0.0	○

002 group-Motor Parameters

Function code	Name	Content	Setting range	Factory	Alteration
02.00	Selection of motor type	0: AC asynchronous motor 1: Reserved Note: This parameter cannot be initialized, please modify it manually	0~1	0	×
02.01	Motor rated power	Set according to the parameters of motor nameplate. Please configure the corresponding motor according to the power of the inverter. If the power difference is too large, the control performance of the inverter will obviously decrease.	0.4~999.9KW	Model setting	×
02.02	Motor rated frequency		0.01Hz~ 【00.13】	50.00	×
02.03	Motor rated rotating speed		0~60000RPM	Model setting	×
02.04	Motor rated Voltage		0~999V	Model setting	×
02.05	Motor rated current		0.1~6553.5A	Model setting	×
02.06	Stator resistance of asynchronous motor		If the motor is tuned, the set values from 02.06 to 02.10 will be updated after the tuning is finished.	0.01~20.000Ω	Model setting
02.07	Rotor resistance of asynchronous motor	0.01~20.000Ω		Model setting	×
02.08	Inductance of stator and rotor of asynchronous motor	0.1~6553.5mH		Model setting	×
02.09	Mutual inductance between stator and rotor of asynchronous motor	0.1~6553.5mH		Model setting	×
02.10	No-load current of asynchronous motor	0.01~655.35A		Model setting	×

HV100 Series High Performance Current Vector Inverter

02.11 ~02.15	Reserved	—	—	0	◆
02.16	Motor tuning selection	0: No action 1: Static tuning 2: No-load complete tuning	0~2	0	×
02.17	Pre-excitation holding time of asynchronous motor	Note: This parameter is invalid for VF control.	0.00~10.00S	Model setting	×
003 group-Reserved					
004group- Speed loop and torque control parameters					
Function code	Name	Content	Setting range	Factory	Alteration
04.00	Speed loop (ASR1) proportional gain	Function codes 01.00 ~ 01.07 are valid in vector control without PG In vector control mode, the speed response characteristics of vector control are changed by setting the proportional gain p and integration time i of the speed regulator.	0.000~6.000	3.0	○
04.01	Speed loop(ASR1) Integral time		0.000~32.000S	0.50	○
04.02	ASR1 filter time constant		0.000~0.100S	0.000	○
04.03	Switch low point frequency		0.00Hz~【04.07】	5.00	○
04.04	Speed loop (ASR2) proportional gain		0.000~6.000	2.0	○
04.05	Speed loop(ASR2) Integral time		0.000~32.000S	1.00	○
04.06	ASR2 filter time constant		0.000~0.100S	0.000	○
04.07	Switch high point frequency		【04.03】~【00.13】	10.00	○
04.08	Positive slip compensation coefficient of vector control (electric state)	In vector control mode, this function code parameter is used to adjust the speed stability accuracy of the motor. When the motor is overloaded and the speed is low, increase this parameter, otherwise decrease this parameter. The positive slip coefficient compensates the speed when the motor slip is positive, whereas the negative slip coefficient compensates the speed when the motor slip is negative. This set value is the percentage of the rated slip frequency of the motor.	50.0%~200.0%	100.0%	○
04.09	Negative slip compensation coefficient of vector control (braking state)		50.0%~200.0%	100.0%	○
04.10	Selection of speed and torque control	0: Speed 1: Torque 2: Condition effective (terminal switching)	0~2	0	×
04.11	Speed and torque switching delay	Set speed and torque switching delay time	0.01~1.00S	0.05	×
04.12	Torque command selection	0: keypad digital given 1: AI1 2: AI2 3: Communication given	0~3	0	○

HV100 Series High Performance Current Vector Inverter

04.13	Keyboard digital setting torque	The set value is a percentage of the rated current of the motor	-200.0%~200.0%	0.0%	○
04.14	Speed limit channel selection 1 for torque control mode (forward direction)	0: keypad digital given1 1: AI1 2: AI2	0~2	0	○
04.15	Speed limit channel selection 1 of torque control mode (reverse direction)	0: keypad digital given2 1: AI1 2: AI2	0~2	0	○
04.16	Keyboard digital limit speed 1	Keyboard digital limit speed 1 to a limit relative to the maximum output frequency. This function code corresponds to the limit value of forward speed when 04.14=0.	0.0~100.0%	100.0%	○
04.17	Keyboard digital limit speed 2	Keyboard digital limit speed 2 to a limit relative to the maximum output frequency. This function code corresponds to the limit value of reverse speed when 04.15=0.	0.0~100.0%	100.0%	○
04.18	Torque rise time	Torque rise/down time defines the time when the torque rises from 0 to the maximum value or falls from the maximum value to 0.	0.0~10.0S	0.1	○
04.19	Torque fall time		0.0~10.0S	0.1	○
04.20	Electric torque limitation in vector mode	Set the Electric torque limit of vector mode, which is a percentage of the rated current of the motor.	G type: 0.0%~200.0% 160.0% P type: 0.0%~200.0% 120.0%	Type setting	○
04.21	Brake torque limitation in vector mode	Set the brake torque limit of vector mode, which is a percentage of the rated current of the motor.	G type: 0.0%~200.0% 160.0% P type: 0.0%~200.0% 120.0%	Type setting	○
04.22	Torque detection action selection	0: Detection invalid 1: Continue to run after detecting torque at constant speed 2: Continue to run after detecting torque during operation 3: Cut off the output after the torque is detected at constant speed 4: Cut off the output after detecting torque in operation 5: Continue running after insufficient torque is detected at constant speed 6: Continue to run after insufficient torque is detected during operation 7: Cut off the output after detecting insufficient torque at constant speed 8: Cut off the output after detecting insufficient torque during operation	0~8	0	×
04.23	Torque detection level	When the actual torque is within 04.24 (torque detection time) and continuously exceeds 04.23 (torque check out level), the inverter will make corresponding actions according to the setting of 04.22. When the set value of torque detection level is 100%, it corresponds to the rated torque of the motor.	G type: 0.0%~200.0% 150.0% P type: 0.0%~200.0% 110.0%	Type setting	×
04.24	Torque detection time		0.0~10.0S	0.0	×
04.25	Cutoff frequency of static friction coefficient	As the starting torque of the motor is not enough, increasing the set value of 04.26 can increase the starting torque. When the speed exceeds the set value of 04.25, the increased torque will slowly decrease to the given torque within the set time of 04.27.	0.00~300.00Hz	10.00	○
04.26	Setting of static friction coefficient		0.0~200.0	0.0	○

HV100 Series High Performance Current Vector Inverter

04.27	Static friction coefficient maintenance time		0.00~600.00s	0.00	×	
005Group-V/F Control Parameter						
Function code	Name	Content	Setting range	Factory	Alteration	
05.00	V/F curve setting	0: Linear curve 1: Torque reduction curve 1(1.3 power) 2: Torque reduction curve 1(1.5 power) 3: Torque reduction curve 1(1.7 power) 4: Square curve 5: V/F curve set by user (determined from 05.01 to 05.06)	0~5	0	×	
05.01	Torque boost setting	Manual torque boost. This setting is a percentage relative to the rated voltage of the motor.	0.0~30.0%	Model setting	×	
05.02	Torque boost cutoff frequency	Set Cutoff frequency of torque boost	0.00~Rated frequency	15.00	×	
05.03	V/F frequency F1		0.00~Frequency value F2	12.50	×	
05.04	V/F voltage V1		0.0~V2	25.0%	×	
05.05	V/F frequency F2		Frequency value 01~Frequency value F3	25.00	×	
05.06	V/F voltage V2		V1~V3	50.0%	×	
05.07	V/F frequency F3		Frequency value 01~ 【02.02】	37.50	×	
05.08	V/F voltage V3		V2~100.0%* rated volt	75.0%	×	
05.09	V/F control slip frequency compensation		The speed of asynchronous motor will decrease after being loaded. Slip compensation can make the speed of motor close to its synchronous speed, thus making the speed control accuracy of motor higher.	0.0~200.0%* rated speed	0.0%	○
05.10	V/F control slip frequency filter coefficient		This parameter is used to adjust the response speed of slip frequency compensation. The larger the setting of this value, the slower the response speed and the more stable the motor speed.	1~10	3	○
05.11	V/F control torque frequency compensation filter coefficient	When the free torque increases, this parameter is used to adjust the response speed of torque compensation. The larger this value is, the slower the response speed and the more stable the motor speed.	0~10	Type setting	○	

HV100 Series High Performance Current Vector Inverter

05.12	Selection of separate V/F control	0: VF semi-separated mode, voltage open loop output 1: VF semi-separated mode, voltage closed loop output 2: VF fully separated mode, voltage open-loop output 3: VF fully separated mode, voltage closed-loop output Note 1: When VF separate control is selected, please turn off the dead zone compensation function of the inverter Note 2: The concept of semi-separation is that the frequency and voltage of the inverter still maintain the relationship of frequency conversion and transformation during starting. When the frequency reaches the set frequency, the voltage and frequency are separated	0~3	0	×
05.13	Voltage given channel	0: Digital given 1: AI1 2: AI2	0~2	0	○
05.14	Voltage feedback channel of voltage closed-loop output	0: AI1 1: AI2 Note: this parameter is only valid for closed-loop output mode	0~1	0	×
05.15	Digitally set the output voltage value	In the open-loop output mode, the maximum output voltage is 100.0% of the rated voltage of the motor.	0.0~200.0%* rated volt	100.0%	○
05.16	Deviation limit of motor closed-loop adjustment	Used to limit the maximum deviation amplitude of voltage regulation in closed-loop mode, so as to limit the voltage within a safe range and ensure the reliable operation of equipment.	0.0~5.0%* rated volt	2.0%	×
05.17	Maximum voltage of VF curve in semi-separated mode	This voltage represents the output voltage of the inverter	0.0~100.0%* rated volt	80.0%	×
05.18	Controller adjustment period of voltage closed-loop output	This function code represents the speed of voltage adjustment. If the voltage response is slow, this parameter value can be appropriately reduced.	0.01~10.00s	0.10	×
05.19	Voltage rising time	05.19 ~ 05.20 is only valid for the voltage open-loop output mode after complete separation.	0.1~3600.0S	10.0	○
05.20	Voltage drop time		0.1~3600.0S	10.0	○
05.21	Voltage feedback disconnection processing	0: Alarm and maintain operation with the voltage at the time of disconnection 1: Alarm and reduce the voltage to limiting voltage for operation 2: Protective action and free parking	0~2	0	×
05.22	Voltage feedback disconnection detection value	The maximum value of the given voltage is taken as the upper limit value of the feedback disconnection detection value. In the feedback disconnection detection time, when the voltage feedback value is continuously less than the feedback disconnection detection value, the inverter will make corresponding protection actions according to the setting of 05.21.	0.0~100.0%* rated volt	2.0%	○
05.23	Voltage feedback disconnection detection time	Duration before protection action after voltage feedback disconnection.	0.0~100.0S	10.0	○

HV100 Series High Performance Current Vector Inverter

05.24	Limiting voltage of voltage feedback disconnection	This voltage represents the output voltage of the inverter, and setting this parameter reasonably can prevent equipment damage caused by voltage overshoot at the time of disconnection.	0.0~100.0%* rated volt	80.0%	○
05.25	DC Bus undervoltage detection value	If DC bus voltage less than the parameter value,the system will report "E-34". If the parameter value set 0, the function is invalid.	0~1000V	0	○
05.26	Reset DC Bus undervoltage fault	If DC bus voltage is the equals of the parameter value,the system will reset the fault "E-34"and run automatically.	0~1000V	0	○
006 group-Analog and pulse input and output parameters					
Function code	Name	Content	Setting range	Factory	Alteration
06.00	A11 input corresponding physical quantity	0: Speed command (output frequency, -100.0%~100.0%) 1: Torque command (output torque, -200.0%~200.0%) 2: Voltage command (output voltage, 0.0%~200.0%* Rated voltage)	0~2	0	×
06.01	A11 input lower limit	Set A11 lower limit	0.00V/0.00mA~ 10.00V/20.00mA	0.00	○
06.02	A11 lower limit corresponds to physical quantity setting	Set A11 lower limit corresponding setting, which corresponds to the percentage of upper limit frequency.	-200.0%~ 200.0%	0.0%	○
06.03	A11 input upper limit	Set A11 upper limit	0.00V/0.00mA~ 10.00V/20.00mA	10.00	○
06.04	A11 upper limit corresponds to physical quantity setting	Set A11 upper limit corresponding setting, which corresponds to the percentage of upper limit frequency.	-200.0%~ 200.0%	100.0%	○
06.05	A11 input Filter time	Set A11 Filter time	0.00S~ 10.00S	0.05	○
06.06	A12 input corresponding physical quantity	0: Speed command (output frequency, -100.0%~100.0%) 1: Torque command (output torque, -200.0%~200.0%) 2: Voltage command (output voltage, 0.0%~200.0%* Rated voltage)	0~2	0	×
06.07	A12 input lower limit	Set A12 lower limit	0.00V~ 10.00V	0.00	○
06.08	A12 lower limit corresponds to physical quantity setting	Set A12 lower limit corresponding setting, which corresponds to the percentage of upper limit frequency.	-200.0%~ 200.0%	0.0%	○
06.09	A12 input upper limit	Set A12 upper limit	0.00V~ 10.00V	10.00	○
06.10	A12 upper limit corresponds to physical quantity setting	Set A12 upper limit corresponding setting, which corresponds to the percentage of upper limit frequency.	-200.0%~ 200.0%	100.0%	○
06.11	A12 input Filter time	Set A12 Filter time	0.00S~ 10.00S	0.05	○

HV100 Series High Performance Current Vector Inverter

06.12	Analog input anti-shake deviation limit	When the analog input signal fluctuates frequently near a given value, the frequency fluctuation caused by this fluctuation can be suppressed by setting 06.12.	0.00V~10.00V	0.00	○
06.13	Zero frequency operation threshold	When 00.15=1 (high frequency mode), the maximum value of this function code is 500.0Hz.	Zero frequency backlash~50.00Hz	0.00	○
06.14	Zero frequency return difference	Set Zero frequency return difference	0.00~Zero frequency operation threshold	0.00	○
06.15	External pulse input corresponds to physical quantity	0: Speed command (output frequency, -100.0%~100.0%) 1: Torque command (output torque, -200.0%~200.0%)	0~1	0	×
06.16	Lower limit of external pulse input	Set the input lower limit frequency of external pulse HDI	0.00~50.00kHz	0.00	○
06.17	The lower limit of external pulse corresponds to the setting of physical quantity	Set the external pulse HDI lower limit to the corresponding setting, which is a percentage relative to the maximum output frequency.	-200.0%~200.0%	0.0%	○
06.18	upper limit of external pulse input	Set the upper limit frequency of external pulse HDI input	0.00~50.00kHz	50.00	○
06.19	The upper limit of external pulse corresponds to the setting of physical quantity	Set the external pulse HDI upper limit to the corresponding setting, which is a percentage relative to the maximum output frequency.	-200.0%~200.0%	100.0%	○
06.20	External pulse input filtering time	Set External pulse input filtering time	0.00S~10.00S	0.05	○
06.21	Function Selection of AO1 Multifunctional Analog Output Terminal	0: Output frequency (before slip compensation) 1: Output frequency (after slip compensation) 2: Set frequency 3: Motor speed (estimated value) 4: Output current 5: Output voltage	0~14	0	○
06.22	Function Selection of AO2 Multifunctional Analog Output Terminal	6: DC Bus Voltage 7: PID given value 8: PID feedback value 9: AI1 10: AI2	0~14	4	○
06.23	Function selection of HDO multi-function pulse output terminal	11: Input pulse frequency 12: Torque current 13: Flux current 14: Communication setting	0~14	11	○
06.24	AO1 output lower limit corresponds to physical quantity	Set AO1 output lower limit corresponds to physical quantity	-200.0%~200.0%	0.0%	○
06.25	AO1 output lower limit	Set AO1 output lower limit	0.00~10.00V	0.00	○
06.26	AO1 output upper limit corresponds to physical quantity	Set AO1 output upper limit corresponds to physical quantity	-200.0%~200.0%	100.0%	○

HV100 Series High Performance Current Vector Inverter

06.27	AO1 output upper limit	Set AO1 output upper limit	0.00~ 10.00V	10.00	○
06.28	AO2 output lower limit corresponds to physical quantity	Set AO2 output lower limit corresponds to physical quantity	-200.0%~ 200.0%	0.0%	○
06.29	AO2 output lower limit	Set AO2 output lower limit	0.00~ 10.00V	0.00	○
06.30	AO2 output upper limit corresponds to physical quantity	Set AO2 output upper limit corresponds to physical quantity	-200.0%~ 200.0%	100.0%	○
06.31	AO2 output upper limit	Set AO2 output upper limit	0.00~ 10.00V	10.00	○
06.32	DO output lower limit corresponding to physical quantity (reservation)	Set DO output lower limit corresponding to physical quantity	-200.0%~ 200.0%	0.0%	○
06.33	DO output lower limit (reservation)	Set DO output lower limit	0.00~ 50.00kHz	0.00	○
06.34	DO output upper limit corresponding to physical quantity (reservation)	Set DO output upper limit corresponding to physical quantity	-200.0%~ 200.0%	100.0%	○
06.35	DO output upper limit (reservation)	Set DO output upper limit	0.00~ 50.00kHz	50.00	○
06.36	AI Related parameters selection	<p>LED single digit: AI1 Multi point curve selection 0: Forbidden 1: Effective</p> <p>LED10-digit: AI2 Multi point curve selection 0: Forbidden 1: Effective</p> <p>LED100-digit: constant of analog signal selection 0: AI1 and AI2 input analog 0~10V 1: AI1 input analog 4~20mA, AI2 input analog 0~10V 2: AI2 input analog 4~20mA, AI1 input analog 0~10V 3: AI1 and AI2 input analog 4~20V</p> <p>LED1000-digit: Reserved</p>	000~311	000	×
06.37	AI1 curve minimum input	<p>AI analog input corresponding setting quantity</p> <p>AI analog maximum input corresponding setting</p> <p>AI curve inflection point 1 input corresponding settings</p> <p>AI curve inflection point 2</p> <p>AI analog input 2 input corresponding settings</p> <p>AI curve minimum input corresponding settings</p>	0.00~ 【06.39】	0.00	○
06.38	AI1 curve minimum input corresponding setting		-200.0%~ 200.0%	0.0%	○
06.39	AI1 curve inflection point 1 input		【06.37】 ~ 【06.41】	3.00	○
06.40	AI1 curve inflection point 1 input corresponding setting		-200.0%~ 200.0%	30.0%	○
06.41	AI1 curve inflection point 2 input		【06.39】 ~ 【06.43】	6.00	○

HV100 Series High Performance Current Vector Inverter

06.42	AI1 curve inflection point 2 input corresponding setting		-200.0%~200.0%	60.0%	○
06.43	AI1 curve maximum input		【06.41】~10.00	10.00	○
06.44	AI1 curve maximum input corresponding setting		-200.0%~200.0%	100.0%	○
06.45	AI2 curve minimum input		0.00~【06.47】	0.00	○
06.46	AI2 curve minimum input corresponding setting		-200.0%~200.0%	0.0%	○
06.47	AI2 curve inflection point 1 input		【06.45】~【06.49】	3.00	○
06.48	AI2 curve inflection point 1 input corresponding setting		-200.0%~200.0%	30.0%	○
06.49	AI2 curve inflection point 2 input		【06.47】~【06.51】	6.00	○
06.50	AI2 curve inflection point 2 input corresponding setting		-200.0%~200.0%	60.0%	○
06.51	AI2 curve maximum input		【06.49】~10.00	10.00	○
06.52	AI2 curve maximum input corresponding setting		-200.0%~200.0%	100.0%	○
06.53	AI1 input voltage protection upper limit	When the value of analog input AI1 is greater than 06.53, or AI1 input is less than 06.54, the inverter Y terminal or relay R outputs "AI1 input overrun" ON signal, which is used to indicate whether the AI1 input voltage is within the set range.	0.00V/0.00mA~10.00V/20.00mA	6.80	○
06.54	AI1 input voltage protection lower limit		0.00V/0.00mA~10.00V/20.00mA	3.10	○
007group-digital input and output parameters					
Function code	Name	Content	Setting range	Factory	Alteration
07.00	Input terminal DI1 function (when 00.01 is 2 or 3, the default function is 58)	0: None 1: Forward rotation control (FWD) 2: Reverse rotation control (REV) 3: Three-wire control 4: Forward jog control 5: Reverse jog control 6: Free stop control 7: External rest signal input(RST)	0~65	1	×

HV100 Series High Performance Current Vector Inverter

07.01	Input terminal DI2 function (when 00.01 is 2 or 3, the default function is 59)	8: External equipment fault normally open (NO) input 9: External equipment fault normally close (NC) input 10: Emergency stop function (brake at the fastest speed) 11: External stop control 12: Frequency increase control(UP) 13: Frequency decrease control(DOWN) 14: UP/DOWN terminal frequency clear 15: Multi-speed selection1 16: Multi-speed selection2 17: Multi-speed selection3 18: Multi-speed selection4 19: Acc/Dec time selection TT1	0~65	2	×
07.02	Input terminal DI3 function (when 00.01 is 2 or 3, the default function is 60)	20: Acc/Dec time selection TT2 21: Run command1 22: Run command2 23: Forbidden acceleration/deceleration 24: Inverter run forbidden command 25: Switch to keypad run command 26: Switch terminal run command 27: Switch communicate run command 28: Auxiliary frequency reset 29: Frequency source A switch to K* B 30: Frequency source A switch to $\Delta + K^* B$ 31: Frequency source A switch to $\Delta - K^* B$ 32: Reserved	0~65	4	×
07.03	Input terminal DI4 Power (when 00.01 is 2 or 3, the default function is 61)	33: PID control input 34: PID control pause 35: Swing frequency control input 36: Swing frequency control pause 37: Rest Swing frequency status 38: PLC control input 39: PLC pause 40: PLC reset	0~65	7	×
07.04	Input terminal DI5 function (when 00.01 is 2 or 3, the default function is 62)	41: Count clearance signal 42: Count trigger signal 43: Timing trigger signal 44: Timing clearance signal	0~65	8	×
07.05	Input terminal DI6 function (when 00.01 is 2 or 3, the default function is 63)	45: Pulse frequency signal (only valid for HDI) 46: Length clearance 47: Length count signal (only valid for HDI) 48: Speed torque switch 49: Torque control forbidden 50~57: Reserved 58: Start/Stop 59: Operating permits 60: Interlock1 61: Interlock2 62: Interlock2	0~65	0	×
07.06	HDI function of input terminal (high speed pulse input)	63: PFC start/stop 64: Frequency source A is switched to B and run 65: PID 1 switch to PID 2	0~65	45	×
07.07	Reserved	—	—	0	◆
07.08	Times of DI	1: Represents 2ms scanning time unit	1~10	5	○

HV100 Series High Performance Current Vector Inverter

	filtering				
07.09	Selection of terminal function detection when power on	0: Terminal running command is invalid when power on 1: Terminal running command is valid when power on	0~1	0	○
07.10	Input logic set (DI1~HDI)	0 means positive logic, that is, the Xi terminal is connected with the public terminal effectively, and the disconnection is invalid 1 means anti-logic, that is, the connection between Xi terminal and public terminal is invalid, and the disconnection is effective	0~7FH	00	×
07.11	FWD/REV mode	0: Two-line control mode1 1: Two-line control mode2 2: Three-wire control mode1 3: Three-wire control mode2	0~3	0	×
07.12	UF/DOWN terminal frequency modification rate	When 00.15=1 (high frequency mode), the maximum value of this function code is 500.0Hz/s:.	0.01~50.00Hz/S	1.00	○
07.13	Reserved	—	—	0	◆
07.14	Y1 output delay time	This function code defines the time delay from the change of state of terminals Y1 and Y2 and relays R1 and R2 to the change of output.	0.0~100.0s	0.0	×
07.15	Y2 output delay time		0.0~100.0s	0.0	×
07.16	R1 output delay time		0.0~100.0s	0.0	×
07.17	R2 output delay time		0.0~100.0s	0.0	×
07.18	Open collector output terminal Y1 setting		0: None 1: FWD run 2: REV run 3: Fault output 4: Frequency/speed detection signal (FDT1) 5: Frequency/speed detection signal (FDT2) 6: Frequency/speed arrival signal (010R) 7: Indication in zero speed operation of inverter 8: Out frequency upper limit 9: Out frequency lower limit 10: The lower limit value of the set frequency reaches at runtime 11: Overload alarm signal of inverter	0~62	0
07.19	Open collector output terminal Y2 setting	12: Counter detection output 13: Counter reset output 14: Inverter ready to run 1 15: Programmable multi-speed operation is completed in one cycle 16: Programmable multi-speed stage operation completed 17: Swing frequency upper and lower limit 18: Current limiting operation 19: Over voltage stall action 20: Under-voltage lockout stop 21: Sleeping 22: Alarm signal (PID disconnection, RS485)	0~62	0	×

HV100 Series High Performance Current Vector Inverter

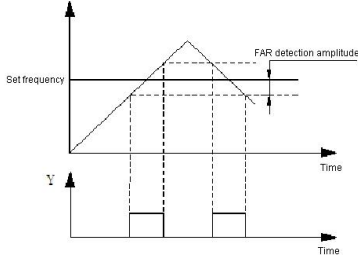
07.20	Programmable relay R1 output	<p>communication failure, keypad communication failure, EEPROM reading and writing failure, encoder disconnection alarm, etc.)</p> <p>23: A11 > A12</p> <p>24: length reach output</p> <p>25: Timing time arrives</p> <p>26: Dynamic braking action</p> <p>27: DC braking action</p> <p>28: Flux braking in action</p> <p>29: Torque is being limited</p> <p>30: Over torque indication</p> <p>31: Auxiliary motor 1</p> <p>32: auxiliary motor 2</p> <p>33: Accumulated running time reached</p> <p>34~49: Multi-stage speed or simple PLC operation stage number indication</p>	0~62	3	×
07.21	Programmable relay R2 output	<p>50: Running indicator signal</p> <p>51: Temperature reached indication</p> <p>52: Indication when the inverter is stopped or running at zero speed</p> <p>53: reserved</p> <p>54: reserved</p> <p>55: Communication settings</p> <p>56: The inverter is ready for operation 2</p> <p>57: A11 input limit exceeded</p> <p>58: The output current exceeds the limit</p> <p>59: Interlock 1 output</p> <p>60: Interlock 2 output</p> <p>61: Interlock 3 output</p> <p>62: Output when frequency and current detection level arrive at the same time</p>	0~62	0	×
07.22	Effective logic setting of output terminal (Y1~Y2)	<p>0: means positive logic, that is, the connection between: Yi terminal and public terminal is effective, and the disconnection is invalid</p> <p>1: means negative logic, that is, the connection between: Yi terminal and public terminal is invalid, and the disconnection is effective</p>	0~3H	0	×
07.23	The frequency reaches the FAR detection width		0.0~100.0%* 【00.13】	10.0%	○
07.24	FDT1 detection mode	<p>0: Frequency set value</p> <p>1: Frequency test value</p>	0~1	0	○

HV100 Series High Performance Current Vector Inverter

07.25	FDT1 level set		0.00Hz~ 【00.13】	50.00	○
07.26	FDT1 lag value		0.0~ 100.0%* 【07.25】	2.0%	○
07.27	FDT2 detection mode	0: Frequency set value 1: Frequency test value	0~1	0	○
07.28	FDT2 level set	Refer to 07.25 ~ 07.26 schematic diagram.	0.00Hz~ 【00.13】	25.00	○
07.29	FDT2 lag value		0.0~ 100.0%* 【07.28】	4.0%	○
07.30	Counter reach	0: Stop counting, stop output 1: Stop counting, continue to output 2: Cycle counting, stop output 3: Cycle counting, continue to output	0~3	3	×
07.31	Counter start condition	0: Always start after power-on 1: Start when running, stop when stopping	0~1	1	×
07.32	Counter reset value setting	This function code defines the count reset value and detection value of the counter. When the count value of the counter reaches the value set by function code 11.21, the corresponding multi-function output terminal (counter reset signal output) outputs an effective signal and clears the counter.	【07.33】~ 65535	0	○
07.33	Counter detection value setting		0~ 【07.32】	0	○
07.34	Timing time reach	0: Stop timing, stop output 1: Stop timing, continue to output 2: Cycle timing, stop output 3: Cycle timing, continue to output	0~3	3	×
07.35	Timing start	0: Always start 1: Run start Stop stop	0~1	1	×
07.36	Timing timer	Set Timing timer	0~65535s	0	○
07.37	Y1 OFF delay time	This function code defines the time delay from the change of state of switch output terminals Y1 and Y2 and relays R1 and R2 to the change of output.	0.0~100.0s	0.0	×
07.38	Y2 OFF delay time		0.0~100.0s	0.0	×
07.39	R1 OFF delay time		0.0~100.0s	0.0	×
07.40	R2 OFF delay time		0.0~100.0s	0.0	×

HV100 Series High Performance Current Vector Inverter

008group-PID Control Parameter					
Function code	Name	Content	Setting range	Factory	Alteration
08.00	PID operation mode	0: Automatic 1: Manually operation through the defined multi-function terminal	0~1	0	×
08.01	PID setting channel selection	0: Digital given 1: AI1 2: AI2 3: Pulse given 4: RS485 communication 5: Pressure given (MPa、Kg) 6: Potentiometer given	0~6	0	○
08.02	Set by digital quantity	When using analog feedback, this function code realizes setting the given quantity of closed-loop control with the keypad, and this function is effective only when the digital given channel of closed-loop is selected (08.01 is 0).	0.0~100.0%	50.0%	○
08.03	PID feedback channel selection	0: AI1 1: AI2 2: AI1+AI2 3: AI1-AI2 4: MAX {AI1, AI2} 5: MIN {AI1, AI2} 6: Pressure given 7: RS485 communication	0~7	0	○
08.04	Advanced characteristic setting of PID controller	LED single digit:PID polarity selection 0: Positive 1: Negative LED10 digit:) Scaling characteristics 0: Constant proportional integral regulation 1: Automatic proportional intergral regulation LED100 digit: Integral regulation characteristic 0: when the frequency reaches the upper and lower limit,stop the integral adjustments 1: when the frequency reaches the upper and lower limit,continue the integral adjustments LED1000 digit: Reserved	000~111	000	×
08.05	Proportional gain KP1	The speed of PID adjustment is set by two parameters: proportional gain and integration time. For fast adjustment, it is necessary to increase proportional gain and reduce integration time; for slow adjustment, it is necessary to reduce proportional gain and increase integration time. Under normal circumstances, the differential time is not set; 0.0: no differentiation.	0.01~100.00	2.50	○
08.06	Integration time Ti1		0.01~10.00s	0.10	○
08.07	Differential time Td1		0.01~10.00s	0.00	○

HV100 Series High Performance Current Vector Inverter

08.08	Sampling period T	Sampling period is the sampling period of feedback, and the regulator operates once in each sampling period. The larger the sampling period, the slower the response, but the better the suppression effect on interference signal, so it is generally unnecessary to set it; 0.00: automatic.	0.01~10.00s	0.10	○
08.09	Deviation limit	The deviation limit is the ratio of the absolute value of the deviation between the feedback amount and the given amount of the system. When the feedback amount is within the deviation limit, the PID adjustment will not act.	0.0~100.0%	0.0%	○
08.10	Closed loop preset frequency	This function code defines the frequency and running time of inverter before PID is put into operation when PID control is effective. In some control systems, in order to make the controlled object reach the preset value quickly, the inverter forcibly outputs a certain frequency value of 08.10 and a frequency holding time of 08.11 according to the setting of this function code. That is, when the control object is close to the control target, the PID controller is put into operation to improve the response speed.	0.00~Upper limit frequency	0.00	○
08.11	Preset frequency holding time		0.0~3600.0s	0.0	×
08.12	Sleep mode	0: Invalid 1: Sleep when the feedback pressure exceeds or falls below the sleep threshold 2: Sleep when feedback pressure and output frequency are stable 3: Reserved	0~3	1	×
08.13	Selection of sleep stop mode	0: Deceleration stop 1: Free stop	0~1	0	○
08.14	Deviation between feedback and set pressure when entering sleep	<p>The diagram illustrates the sleep mode 1 operation. It shows a graph with PID feedback (dashed line) and output frequency (solid line). Key levels include Sleep min, PID settings, Wake up min value, Lower rate frequency, and Zero frequency. The process starts with a rise in feedback, followed by a drop in output frequency to zero. A 'Sleep detection time' interval is shown. The system then enters a 'Sleep' state. A 'Wake-up detection time' interval follows, after which the system 'Wakes up', and the output frequency returns to a 'Lower rate frequency' level.</p>	0.0~10.0%	0.5%	○
08.15	Sleep threshold		0.0 ~ 200.0% * set pressure	100.0%	○
08.16	Wake threshold		0.0 ~ 200.0% * set pressure	90.0%	○
08.17	Sleep delay time	08.12=1 schematic diagram (sleep mode 1)	0.0~3600.0s	100.0	○

HV100 Series High Performance Current Vector Inverter

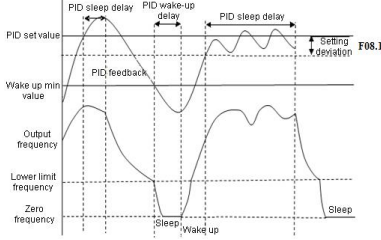
08.18	Wake delay time	 <p style="font-size: small;">08.12=2 schematic diagram (sleep mode 2)</p>	0.0~ 3600.0s	5.0	○
08.19	Proportional gain KP2	<p>The speed of PID adjustment is set by two parameters: proportional gain and integration time. For fast adjustment, it is necessary to increase proportional gain and reduce integration time; for slow adjustment, it is necessary to reduce proportional gain and increase integration time. Under normal circumstances, the differential time is not set; 0.0: no differentiation.</p>	0.01~ 100.00	1.00	○
08.20	Integration time Ti2		0.01~ 10.00s	0.10	○
08.21	Differential time Td2		0.01~ 10.00s	0.00	○
08.22	Upper limit cut-off frequency of PID	Set PID upper limit cut-off frequency	【08.23】~ 300.00Hz	50.00	×
08.23	Lower limit cut-off frequency of PID	Set PID lower limit cutoff frequency	-300.00Hz ~ 【08.22】	0.00	×
08.24	Sleep frequency	Set Sleep frequency	0.00Hz~ 【00.13】	0.00	×
009Group-PLC、Multistage speed、Swing frequency and Fix length control					
Function code	Name	Content	Setting range	Factory	Alteration
09.00	Selection of PLC operation mode	0: stop after single cycle 1: Keep the final value running after a single cycle 2: Limited times continuous cycle 3: Continuous cycle	0~3	0	×
09.01	Operation mode of PLC	0: Automatic 1: Manually operation through the defined multi-function terminal	0~1	0	×
09.02	Memory of PLC running power failure	0: Not store 1: Remember the stage and frequency of power-down time	0~1	0	×
09.03	PLC starting mode	0: Restart 1: Start from the stage of shutdown (failure) time 2: Start from the stage and frequency of shutdown (failure) time	0~2	0	×
09.04	Finite number of continuous cycles	Set PLG Finite cycle number	1~65535	1	○
09.05	Selection of PLC running time unit	0: s 1: min	0~1	0	×
09.06	Multistage speed frequency 0	Set Multistage speed frequency 0	-Upper limit frequency~ Upper limit frequency	5.00	○
09.07	Multistage speed frequency 1	Set Multistage speed frequency 1	-Upper limit frequency~ Upper limit frequency	10.00	○
09.08	Multistage speed frequency 2	Set Multistage speed frequency 2	-Upper limit frequency~ Upper limit frequency	15.00	○

HV100 Series High Performance Current Vector Inverter

09.09	Multistage speed frequency 3	Set Multistage speed frequency 3	-Upper limit frequency~ Upper limit frequency	20.00	○
09.10	Multistage speed frequency 4	Set Multistage speed frequency 4	-Upper limit frequency~ Upper limit frequency	25.00	○
09.11	Multistage speed frequency 5	Set Multistage speed frequency 5	-Upper limit frequency~ Upper limit frequency	30.00	○
09.12	Multistage speed frequency 6	Set Multistage speed frequency 6	-Upper limit frequency~ Upper limit frequency	40.00	○
09.13	Multistage speed frequency 7	Set Multistage speed frequency 7	-Upper limit frequency~ Upper limit frequency	50.00	○
09.14	Multistage speed frequency 8	Set Multistage speed frequency 8	-Upper limit frequency~ Upper limit frequency	0.00	○
09.15	Multistage speed frequency 9	Set Multistage speed frequency 9	-Upper limit frequency~ Upper limit frequency	0.00	○
09.16	Multistage speed frequency 10	Set Multistage speed frequency 10	-Upper limit frequency~ Upper limit frequency	0.00	○
09.17	Multistage speed frequency 11	Set Multistage speed frequency 11	-Upper limit frequency~ Upper limit frequency	0.00	○
09.18	Multistage speed frequency 12	Set Multistage speed frequency 12	-Upper limit frequency~ Upper limit frequency	0.00	○
09.19	Multistage speed frequency 13	Set Multistage speed frequency 13	-Upper limit frequency~ Upper limit frequency	0.00	○
09.20	Multistage speed frequency 14	Set Multistage speed frequency 14	-Upper limit frequency~ Upper limit frequency	0.00	○
09.21	Multistage speed frequency 15	Set Multistage speed frequency 15	-Upper limit frequency~ Upper limit frequency	0.00	○
09.22	0th stage speed acceleration and deceleration time	Set the 0th stage speed acceleration and deceleration time	0~3	0	○
09.23	0th stage speed running time	Set the 0th stage speed running time	0.0~6553.5s (min)	0.0	○
09.24	1st speed acceleration and deceleration time	Set the 1st stage speed acceleration and deceleration time	0~3	0	○
09.25	1st speed running time	Set the 1st stage speed running time	0.0~6553.5s (min)	0.0	○
09.26	2nd speed acceleration and deceleration time	Set the 2nd stage speed acceleration and deceleration time	0~3	0	○
09.27	2nd speed running time	Set the 2nd stage speed running time	0.0~6553.5s (min)	0.0	○
09.28	3rd speed acceleration and deceleration time	Set the 3rd stage speed acceleration and deceleration time	0~3	0	○
09.29	3rd speed running time	Set the 3rd stage speed running time	0.0~6553.5s (min)	0.0	○

HV100 Series High Performance Current Vector Inverter

09.30	4th speed acceleration and deceleration time	Set the 4th stage speed acceleration and deceleration time	0~3	0	○
09.31	4th speed running time	Set the 4th stage speed running time	0.0~6553.5s (min)	0.0	○
09.32	5th speed acceleration and deceleration time	Set the 5th stage speed acceleration and deceleration time	0~3	0	○
09.33	5th speed running time	Set the 5th stage speed running time	0.0~6553.5s (min)	0.0	○
09.34	6th speed acceleration and deceleration time	Set the 6th stage speed acceleration and deceleration time	0~3	0	○
09.35	6th speed running time	Set the 6th stage speed running time	0.0~6553.5s (min)	0.0	○
09.36	7th speed acceleration and deceleration time	Set the 7th stage speed acceleration and deceleration time	0~3	0	○
09.37	7th speed running time	Set the 7th stage speed running time	0.0~6553.5s (min)	0.0	○
09.38	8th speed acceleration and deceleration time	Set the 8th stage speed acceleration and deceleration time	0~3	0	○
09.39	8th speed running time	Set the 8th stage speed running time	0.0~6553.5s (min)	0.0	○
09.40	9th speed acceleration and deceleration time	Set the 9th stage speed acceleration and deceleration time	0~3	0	○
09.41	9th speed running time	Set the 9th stage speed running time	0.0~6553.5s (min)	0.0	○
09.42	10th speed acceleration and deceleration time	Set the 10th stage speed acceleration and deceleration time	0~3	0	○
09.43	10th speed running time	Set the 10th stage speed running time	0.0~6553.5s (min)	0.0	○
09.44	11th speed acceleration and deceleration time	Set the 11th stage speed acceleration and deceleration time	0~3	0	○
09.45	11th speed running time	Set the 11th stage speed running time	0.0~6553.5s (min)	0.0	○
09.46	12th speed acceleration and deceleration time	Set the 12th stage speed acceleration and deceleration time	0~3	0	○
09.47	12th speed running time	Set the 12th stage speed running time	0.0~6553.5s (min)	0.0	○
09.48	13th speed acceleration and deceleration time	Set the 13th stage speed acceleration and deceleration time	0~3	0	○
09.49	13th speed running time	Set the 13th stage speed running time	0.0~6553.5s (min)	0.0	○
09.50	14th speed acceleration and deceleration time	Set the 14th stage speed acceleration and deceleration time	0~3	0	○
09.51	14th speed running time	Set the 14th stage speed running time	0.0~6553.5s (min)	0.0	○
09.52	15th speed acceleration and deceleration time	Set the 15th stage speed acceleration and deceleration time	0~3	0	○
09.53	15th speed running time	Set the 15th stage speed running time	0.0~6553.5s (min)	0.0	○
09.54	Reserved	—	—	0	◆

HV100 Series High Performance Current Vector Inverter

09.55	Swing frequency control	0: Invalid 1: Effective	0~1	0	×
09.56	Swing frequency operation mode	0: Automatic 1: Manually operation through the defined multi-function terminal	0~1	0	×
09.57	Swing amplitude control	0: Fixed swing 1: Variable swing	0~1	0	×
09.58	Swing frequency stop/starting mode selection	0: Start according to the state memorized before stopping 1: Restart	0~1	0	×
09.59	Power-down storage of frequency swing state	0: Store 1: Not store	0~1	0	×
09.60	Swing preset frequency	The frequency at which the frequency converter operates before it enters the swing operation mode or when it leaves the swing operation mode and the time it runs at this frequency point. If the function code 09.61≠0 (swing frequency preset frequency waiting time) is set, the inverter directly enters the swing frequency preset frequency operation after starting, and enters the swing frequency mode after the swing frequency preset frequency waiting time.	0.00Hz~ Upper limit frequency	10.00	○
09.61	Swing preset frequency waiting time		0.0~ 3600.0s	0.0	×
09.62	Swing amplitude	The amplitude of Swing frequency is determined by 09.62, and the operating frequency of swing frequency is restricted by the upper and lower frequencies. If it is set improperly, the Swing frequency will not work normally.	0.0~ 100.0%	0.0%	○
09.63	Jump frequency	This function code refers to the amplitude of rapid decline after the frequency reaches the upper limit frequency of the swing frequency, and of course it also refers to the amplitude of rapid rise after the frequency reaches the lower limit frequency of the swing frequency. If it is set to 0.0%, there is no sudden jump frequency.	0.0~50.0% (Relative swing frequency amplitude)	0.0%	○
09.64	Swing frequency rise time	This function code defines the running time from the lower limit frequency to the upper limit frequency and from the upper limit frequency to the lower limit frequency.	0.1~ 3600.0s	5.0	○
09.65	Swing frequency falling time		0.1~ 3600.0s	5.0	○
09.66	Reserved	—	—	0	◆
09.67	Fixed length control	0: Invalid 1: Effective	0~1	0	×
09.68	Set length	This set of functions is used to realize the fixed-length shutdown function. The frequency converter inputs counting pulses from the terminal (HDI defined as function 47), and obtains the calculated length according to the number of pulses per revolution of the speed measuring shaft (09.73) and the circumference of the shaft (09.72). Calculation length = count pulse number ÷ Number of pulses per revolution × Measure the circumference of shaft. The calculated length is corrected by length magnification (09.70) and length correction coefficient (09.71), and the actual length is obtained.	0.000~ 65.535(KM)	0.000	○
09.69	Actual length		0.000~ 65.535(KM)	0.000	○
09.70	Length magnification		0.100~ 30.000	1.000	○
09.71	Length correction coefficient		0.01~1.000	1.000	○

HV100 Series High Performance Current Vector Inverter

09.72	Measure the circumference of shaft	Actual length = calculated length × Length magnification + Length correction factor.	0.10~100.00CM	10.00	○
09.73	Number of pulses per rotation of shaft (HDI)	When the actual length (09.69) ≥ the set length (09.68), the inverter will automatically issue a shutdown instruction to stop. The actual length (09.69) should be cleared or modified before running again < Set the length (09.68), otherwise it will not start.	1~65535	1024	○
010 group-Protect Parameters					
Function code	Name	Content	Setting range	Factory	Alteration
10.00	Motor Overload protection selection	LED single digit: motor overload protect mode: 0: Forbid 1: Common motor (Electronic thermal relay mode, low speed with compensation) 2: Variable frequency motor (Electronic thermal relay mode, low speed without compensation) 3: User defined mode LED10 digit: inverter overload protect mode: 0: Forbid 1: Common mode 2: User defined mode LED100 digit: inverter overload alarm : 0: Forbid 1: Effective LED1000 digit: Reserved Note: please refer to 10.29 ~ 10.32 for the description of user defined overload protection.	000~123	11	×
10.01	Motor overload protection coefficient	20.0%~120.0%	20.0%~120.0%	100.0%	×
10.02	Undervoltage protection action selection	0: Forbid 1: Allowed (undervoltage is regarded as fault)	0~1	0	×
10.03	Undervoltage protection level	This function code specifies the allowable lower limit voltage of DC bus when the inverter works normally.	220V: 180~280V 200V 380V: 330~480V 350V	Type setting	×
10.04	Overvoltage limit level	Overvoltage limit level defines the operating voltage during overvoltage stall protection.	220V: 350~390V 370V 380V: 600~780V 660V	Type setting	×
10.05	Voltage limit coefficient during deceleration	In the process of deceleration, the larger this value is, the stronger the ability to suppress overvoltage is. 0: Overvoltage stall protection is invalid.	0~100	Type setting	×
10.06	Current limit level(only VF mode is valid)	Overcurrent limit level defines the operating current during overcurrent stall protection.	80%~200%* INV rated current	Type setting	×
10.07	Selection of current limit in weak magnetic field	0: Limited by 10.06 current limit level 1: Limited by the converted current limit level of 10.06	0~1	0	×
10.08	Current limiting coefficient during acceleration	In the process of acceleration, the larger this value is, the stronger the ability of restraining overcurrent is. 0: acceleration current limit is invalid.	0~100	Type setting	×
10.09	Current limiting coefficient during constant speed	0 ~ 100 is automatic frequency reduction, and the larger the coefficient, the faster the frequency reduction rate; 101 ~ 5000 means manual frequency reduction, 101	0~5000	40	×

HV100 Series High Performance Current Vector Inverter

		means 0.01Hz /s, and so on, and 5000 means 50.00/s.			
10.10	Drop load detection time	The load drop detection time (10.10) defines that the output current of the frequency converter is less than the load drop detection level (10.11) for more than a certain time, and then the load drop signal is output; 0: the load drop detection is invalid.	0.1S~60.0S	5.0	○
10.11	Drop load detection level		0~100%* INV rated current	0%	○
10.12	Overload pre-alarm level	By setting the parameters 10.12 A-09 10.13 ,when the output current of the frequency converter is greater than the overload pre-alarm level amplitude (10.12), the frequency converter outputs the pre-alarm signal after delay (10.13), which is displayed on the keypad	20%~200%* INV rated current	Type setting	○
10.13	Overload pre-alarm delay time		0.0~30.0s	10.0	○
10.14	Temperature detection threshold	By setting function No.51 in function codes 07.18 ~ 07.21, when the temperature reaches this setting, an indication signal is output.	0.0℃~90.0℃	65.0℃	×
10.15	Selection of input and output phase lose protection	0: Prohibit 1: Input protection invalid, output protection valid 2: Input protection valid, output protection invalid 3: All valid	0~3	Type setting	×
10.16	Input phase loss protection delay time	When the input phase lose protection is selected to be effective and the input phase lose fault occurs, the inverter will protect E-12 after the time defined in 10.16, and stop freely.	0.0~30.0s	1.0	○
10.17	Output phase lose protection detection reference	When the actual output current of the motor is greater than the rated current * [10.17], if the output phase failure protection is effective, after a delay time of 5S ,the inverter protection will act [E-13], and stop freely.	0%~100%* INV rated current	25%	×
10.18	Output current unbalance detection coefficient	If the ratio of the maximum value to the minimum value in the three-phase output current is greater than this coefficient, and the duration exceeds 10 seconds, the inverter will report the output current imbalance fault E-13.	0.01~50.00	10.00	×
10.19	Reserved	—	—	0	◆
10.20	Treatment of PID feedback disconnection	0: No action 1: Alarm and maintain operation at the frequency of disconnection time 2: Protection action and free stop 3: Alarm and decelerate to zero speed according to the set mode	0~3	0	×
10.21	Feedback disconnection detection value	The maximum value given by PID is taken as the upper limit value of feedback disconnection detection value. In the feedback disconnection detection time, when the feedback value of PID is continuously less than the feedback disconnection detection value, the inverter will make corresponding protection actions according to the setting of 09.20.	0.0~100.0%	0.0%	○
10.22	Feedback disconnection detection time	Feedback the duration after disconnection and before protection action.	0.0~3600.0S	10.0	○
10.23	Setting of FDT1 current detection level	See function No.62 in 07.18 ~ 07.21 for details	0.~200.0%	0	◆

HV100 Series High Performance Current Vector Inverter

10.24	Selection of RS485 communication abnormal action	0: Protection action and free stop 1: Alarm and maintain the status to continue operation 2: Alarm and stop according to the stop mode	0~2	1	×
10.25	RS485 communication timeout detection time	If RS485 communication fails to receive the correct data signal within the time interval defined by this function code, it is considered that RS485 communication is abnormal, and the inverter will make corresponding actions according to the setting of 10.24. When this value is set to 0.0, RS485 communication timeout detection is not performed.	0.0~100.0s	0.0	○
10.26	Keypad communication abnormal action selection	0: Protection action and free stop 1: Alarm and maintain the status to continue operation 2: Alarm and stop according to the stop mode	0~2	1	×
10.27	Keypad communication timeout check-out time	If the keypad communication fails to receive the correct data signal within the time interval defined by this function code, it is considered that the keypad communication is abnormal, and the inverter will make corresponding actions according to the setting of 10.26.	0.0~100.0s	1.0	○
10.28	EEPROM reading and writing error action selection	0: Protection action and free stop 1: Alarm and maintain the status to continue operation	0~1	0	×
10.29	Motor overload protection threshold	When the 10.00 bit is set to 3, the output current reaches the motor overload protection threshold (10.29), and then delays the motor overload protection detection time (10.30) and reports the motor overload E-08.	0~200%* Motor rated current	150%	×
10.30	Motor overload protection detection time		0~60000S	100	○
10.31	Inverter overload protection threshold	When 10.00 bit is 2, the output current reaches the overload protection threshold of inverter (10.31), and then delays the overload protection detection time of inverter (10.32), and then reports the overload of inverter E-09.	0~200%* INV rated current	150%	×
10.32	Inverter overload protection detection time		0~60000S	60	○
10.33	OC and module fault limit reset times	When the failure times of OC and module exceed this set value, it needs to be powered on again before resetting.	0~9999	5	○
10.34	Selection of encoder frequency adjustment start bit	0: LED units 1: LED tens 2: LED hundreds 3: LED thousands	0~3	0	○
10.35	Reserved	—	—	0	◆
011Group-RS485 communication parameters					
Function code	Name	Content	Setting range	Factory	Alteration
11.00	Protocol selection	0: MODBUS 1: User defined	0~1	0	×
11.01	Local address	0: Broadcast address 1~247: Slave station	0~247	1	×
11.02	Communication baud rate setting	0: 2400BPS 1: 4800BPS 2: 9600BPS 3: 19200BPS 4: 38400BPS 5: 115200BPS	0~5	3	×

HV100 Series High Performance Current Vector Inverter

11.03	Date format	<p>0: No check (N, 8, 1) for RTU 1: Parity check (E, 8, 1) for RTU 2: Odd parity check (O, 8, 1) for RTU 3: No check (N, 8, 2) for RTU 4: Parity check (E, 8, 2) for RTU 5: Odd parity check (O, 8, 2) for RTU</p>	0~5	1	×
11.04	Local machine response delay time	<p>This function code defines the intermediate time interval between receiving the data frame of the inverter and sending the response data frame to the upper computer. If the response time is less than the system processing time, the system processing time shall prevail. If the delay is longer than the system processing time, the system will delay waiting after processing the data, and then send the data to the upper computer until the response delay time is up.</p>	0~200ms	5	×
11.05	Transmission response processing	<p>0: Write response 1: Write not response</p>	0~1	0	×
11.06	Proportional linkage coefficient	<p>This function code is used to set the coefficient of the frequency command received through the RS485 interface when the inverter is used as a slave. The actual operating frequency is equal to the value of this function code multiplied by the frequency setting command value received through the RS485 interface. In linked control, this function code can set the ratio of the running frequency of multiple inverters.</p>	0.01~10.00	1.00	○
11.07	Transmission mode selection	<p>LED single digit: Communication mode selection 0: General mode 1: Reserved 2: Reserved 3: Reserved 4: Reserved LED10 digit: Broadcast frequency source selection 0: host set frequency 1: Host frequency source A 2: Host frequency source B LED100 digit: Reserved LED1000 digit: Reserved</p>	00~24	00	×

HV100 Series High Performance Current Vector Inverter

11.08	Communication display selection	<p>LED single digit: Display and selection of communication bus voltage</p> <p>0: Normal display 1: Magnify 10 times 2: Magnify 100 times 3: Shrink 10 times 4: Shrink 100 times</p> <p>LED10 digit: Communication current display selection</p> <p>0: Normal display 1: Magnify 10 times 2: Magnify 100 times 3: Shrink 10 times 4: Shrink 100 times</p> <p>LED100 digit: Operation frequency display selection</p> <p>0: Normal display 1: Magnify 10 times 2: Magnify 100 times 3: Shrink 10 times 4: Shrink 100 times</p> <p>LED1000 digit: Reserved</p>	000~444	000	×
-------	---------------------------------	--	---------	-----	---

012 Group-Advanced functions and performance parameters

Function code	Name	Content	Setting range	Factory	Alteration
12.00	Energy consumption braking function setting	0: Invalid 1: Valid throughout 2: Only valid when decelerating	0~2	1	×
12.01	Energy consumption braking starting voltage	<p style="text-align: center;"> $F012.03 = \frac{t02n}{t02n - t02ff} * 100\%$ </p>	220V: 340 ~ 380V 360V 380V: 660 ~ 760V 680V	Type setting	○
12.02	Energy consumption braking return difference voltage		220V: 10 ~ 100V 5V 380V: 10 ~ 100V 10V	Type setting	○
12.03	Energy consumption braking action ratio		10~100%	100%	○
12.04	Power failure restart settings	0: Forbid 1: Starting from starting frequency 2: Speed tracking start	0~2	0	×
12.05	Waiting time for restart after power failure	During the waiting time for restart, any operation instruction entered is invalid. If the shutdown command is input, the inverter will automatically release the speed tracking restart state and return to the normal shutdown state.	0.0~60.0s	5.0	×

HV100 Series High Performance Current Vector Inverter

12.06	Automatic fault reset times	The frequency of automatic fault reset is set by 12.06. When the number of fault resets is set to 0, there is no automatic reset function, and it can only be reset manually. When 12.06 is set to 100, the number of times is unlimited, that is, countless times.	0~100	0	×
12.07	Automatic fault reset interval	After a fault occurs during operation, the inverter stops outputting and displays the fault code. After the reset interval set in 12.07, the inverter automatically resets the fault and restarts the operation according to the set starting mode.	0.1~60.0s	3.0	×
12.08	Cooling fan control	0: automatic control mode 1: Always running during power-on 2: The fan will work when the temperature is higher than 50℃, and the fan will not work when the temperature is lower than 45℃.	0~2	0	○
12.09	Password for running restricted function	By default, the password is 0, and 12.10 and 12.11 can be set; When there is a password, 12.10 and 12.11 can only be set after the password is verified correctly.	0~65535	0	○
12.10	Selection for running restricted function	0: Forbid 1: Effective	0~1	0	○
12.11	Run limit time	Set Run limit time	0~65535(h)	0	×
12.12	Frequency drop point at instantaneous power failure	If the inverter bus voltage drops below 12.12* rated bus voltage, and the instantaneous stop control is effective, the instantaneous stop starts to act.	220V:180 ~ 330V 250V 380V:300 ~ 550V 450V	Type setting	×
12.13	Frequency drop coefficient of instantaneous power failure	The larger the value is, the faster the frequency reduction rate is. 0: the instantaneous stop function is invalid.	0~100	0	○
12.14	Drooping control	0.00: The droop control function is invalid When multiple inverters drive the same load, the load distribution is unbalanced due to different speeds, which makes the inverters with higher speeds bear heavier loads. The droop control characteristic is that the speed droops with the increase of load, which can make the load evenly distributed; This parameter adjusts the frequency variation of inverter with drooping speed.	0.00 ~ 10.00Hz	0.00	×
12.15	Speed tracking waiting time	Before the inverter speed tracking starts, start tracking after the delay.	0.1~5.0S	1.0	×
12.16	Speed tracking current limiting level	In the process of speed tracking, this function code plays the role of automatic current limiting. When the actual current reaches the threshold (12.16), the inverter reduces the frequency and limits the current, and then continues to track and accelerate; The set value is a percentage relative to the rated current of the inverter.	80 % ~ 200 % * INV Rtd current	100%	×

HV100 Series High Performance Current Vector Inverter

12.17	Speed tracking speed	When speed tracking restarts, select the speed of speed tracking. The smaller the parameter, the faster the tracking speed. But too fast may lead to unreliable tracking.	1~125	25	×
12.18	PWM mode	<p>LED single digit: PWM synthesis mode 0: Full frequency seven segment 1: The seven paragraph turns to the five paragraph</p> <p>LED10-digit: temperature correlation 0: Forbid 1: Effective</p> <p>LED100-digit: Frequency correlation 0: All invalid 1: Low frequency adjustment, High frequency adjustment 2: Low frequency doesn't adjust, High frequency adjustment 3: Low frequency adjustment, High frequency doesn't adjust</p> <p>LED1000-digit: Soft PWD function 0: invalid 1: Effective</p>	0000~1311	001	×
12.19	Voltage control function	<p>LED single digit: AVR function 0: Forbid 1: All Effective 2: Forbid only slow down</p> <p>LED10 digit: Overmodulation selection 0: invalid 1: Effective</p> <p>LED100 digit: Choice of death compensation 0: Forbid 1: Effective</p> <p>LED1000 digit: Shock suppression selection 0: invalid 1: Oscillation suppression mode 1 2: Oscillation suppression mode 2 3: Oscillation suppression mode 3</p>	0000~3112	2112	×
12.20	Oscillation suppression starting frequency	Set oscillation suppression start frequency	0.00 ~ 300.00Hz	Type setting	○
12.21	Magnetic flux braking selection	This parameter is used to adjust the magnetic flux braking ability of the inverter during deceleration. The larger this value is, the stronger the magnetic flux braking ability is. To a certain extent, the shorter the deceleration time, the parameter generally does not need to be set. When this value is 0, this function is invalid. When the overvoltage limit level is set low, turning on this function can shorten the deceleration time appropriately. When the overvoltage limit level is set high, it is not necessary to turn on this function.	0~100	0	○
12.22	Energy saving control coefficient	0: Invalid 1: Automatic Note: Energy-saving operation is only effective for ordinary V/F control	0~100	0	○
12.23	Multi-speed priority enable	0: Forbid 1: Multi segment speed takes precedence over 00.07	0~1	0	×
12.24	JOG priority enable	0: Invalid 1: JOG has the highest priority	0~1	0	×

HV100 Series High Performance Current Vector Inverter

12.25	Special function	LED single digit: AO2 and DO selection 0: AO2 Effective 1: DO Effective LED10 digit: IPM Fault setting 0: Shield the fault 1: the fault is Effective LED100 digit: input phase failure rest selection 0: Unable to reset 1: it can be reset after the power supply is normal LED1000 digit: Reserved	000~110	010	×
12.26	Upper limit frequency of oscillation suppression	Set Upper limit frequency of oscillation suppression	0.00~300.00Hz	50.00	○
12.27	Oscillation suppression coefficient	When 12.19 kilobits =1 (oscillation suppression mode 1), the PWM mode is forced to be five-segment; When 12.19 kilobits =2 (oscillation suppression mode 2), the original mode remains unchanged, and these two modes can be adjusted by oscillation suppression coefficient (12.27). In special occasions, if the first two modes cant suppress the oscillation, use the oscillation suppression mode 3 (12.19 thousands of bits =3), and adjust it together with the parameters 12.27 (oscillation suppression coefficient) and 12.28 (oscillation suppression voltage).	1~500	50	○
12.28	Oscillation suppression voltage		0.0~25.0%* Rtd volt	5.0	○
12.29	Wave-by-wave current limiting and anti-overvoltage action options	LED single digit: Selection of wave by wave current limiting acceleration 0: Forbid 1:Effective LED10 digit: Selection in wave by wave current limiting deceleration 0: Forbid 1:Effective LED100 digit: Selection of wave by wave current limiting and constant speed 0: Forbid 1:Effective LED1000 digit: Anti-overvoltage action selection 0: Forbid 1:Effective	0000~1111	011	○
12.30	Special function selection	LED single digit: Direct-Start function select 0: Forbid 1: Effective LED 10 digit: display selection of over-torque alarm A-05 0: Forbid 1: Effective LED100 digit: Reserved LED1000 digit: Reserved	00~11	Type setting	○
013 Group-Reserved					
014 Group Keypad function setting and parameter management					
Function code	Name	Content	Setting range	Factory	Alteration
14.00	M-FUNC function selection	0: JOG(Point control) 1: Forward/Reverse switch 2: Clear▲/▼ *frequency setting 3: Local/Remote operation switch(Reserved) 4: Reverse direction	0~4	0	×
14.01	STOP/RST key function Selection	0: Only valid for keypad control 1: Effective for both keypad and terminal control 2: Effective for keypad and communication control 3: Valid for all control modes	0~3	3	○

HV100 Series High Performance Current Vector Inverter

14.02	STOP+RUN key emergency stop function	0: Forbid 1: Free stop	0~1	1	○
14.03	Closed loop display coefficient	This function code is used to correct the display error between the actual physical quantity (pressure, flow, etc.) and the given or feedback quantity (voltage, current) during closed-loop control, and has no influence on closed-loop adjustment.	0.01 100.00	~ 1.00	○
14.04	Load speed display coefficient	This function code is used to correct the display error of speed scale, and has no influence on the actual speed.	0.01 100.00	~ 1.00	○
14.05	Line speed coefficient	This function code is used to correct the display error of linear speed scale, and has no influence on the actual speed.	0.01 100.00	~ 1.00	○
14.06	Encoder adjustment rate	The larger the value, the faster the encoder adjusts	1~100	70	○
14.07	Monitoring parameter selection 1 in running state (main display)	The monitoring items of the main monitoring interface can be changed by changing the set values of the above function codes. For example, if 14.07=5, that is, the output current d-05 is selected, the default display item of the main monitoring interface is the current output current value during operation.	0~57	0	○
14.08	Monitoring parameter selection 2 in running state (Auxiliary display)		0~57	5	○
14.09	Monitoring parameter selection 1 in stop state (main display)		0~57	1	○
14.10	Monitoring parameter selection 2 in stop state (Auxiliary display)	The monitoring items of the main monitoring interface can be changed by changing the set values of the above function codes. For example, if 14.09=6, that is, the output voltage d-06 is selected, the default display item of the main monitoring interface will be the current output voltage value when the machine stops.	0~57	13	○
14.11	Parameter display mode selection	LED ones: function parameter display mode selection 0: display all function parameters 1: only display the parameters that are different from the factory value 2: only display the parameters modified after the last power-on (reserved) LED ten digits: monitor parameter display mode selection 0: only display main monitor parameters 1: Main and auxiliary display alternately (interval time 1s) LED hundreds: adjust frequency display selection 0: display frequency 1: Only display status monitoring parameters Thousands of LED: Panel ▲/▼ key adjustment enable 0: Valid 1: invalid	0000~1112	0100	○
14.12	Parameter initialization	0: No operation 1: All parameters except motor parameters are restored to factory settings 2: Restore all user parameters to factory settings 3: Clear fault record	0~3	0	×
14.13	Parameter protect	0: Modify all Parameter (Some parameters cannot be modified during operation) 1: only the frequency settings 00.07 and 00.10 and this function code can be modified 2: All parameters except this function code are forbidden to be modified Note: the above restrictions are invalid for this function code and 14.13	0~2	0	○

HV100 Series High Performance Current Vector Inverter

14.14	Parameter copy	0: No operation 1: Upload parameters to the keypad 2: Download all function code parameters to the inverter 3: Download all function code parameters except motor parameters to the inverter Note 1: When selecting parameter download, the software will judge whether the inverter power specifications are consistent. If they are inconsistent, the parameters related to the model will not be modified. Note 2: Only the external keyboard KB2 has the copy function, and the normal keyboard copy will prompt an error.	0~3	0	×
14.15	Software version	14.15~14.16 View only, cannot be modified.	1.00~99.99	4.12	◆
14.16	Keypad version		1.00~99.99	1.00	◆
14.17	INV rated power	This parameter can only be viewed and cannot be modified.	0.4 999.9KW (G/P) ~	Type setting	◆
14.18	Inverter selection type	0: G type (constant torque load model) 1: P type (load type of fan and water pump) Note 1: After setting as P type machine, the motor parameters will be refreshed automatically, and it can be used as a higher gear special frequency converter for fan and water pump without changing any parameters. Note 2: This parameter cannot be initialized, please modify it manually	0~1	0	×

015 Group-Multiple pumps water supply parameters

Function code	Name	Content	Setting range	Factory	Alteration
15.00	Terminal delay time	The delay time when the pump is switched on and off.	0.0~600.0s	0.1	○
15.01	Polling time	Polling time is the time to switch the variable frequency pump regularly, which is only valid when a single pump works.	0.0~600.0h	48.0	○
15.02	Lower limit frequency for reducing the number of pumps	When the feedback pressure is higher than the set pressure and the frequency drops to the lower limit frequency of pump reduction, the pump is reduced after the delay time of pump reduction.	0.0 ~ 600.00HZ	35.00	×
15.03	Main pump Start-up delay time	This parameter is used in the "one drive three constant pressure water supply", the main pump start delay time after the main and auxiliary pumps are switched.	0.0 ~ 3600.0s	0.0	○
15.04	Auxiliary pump Start-up mode	0: Direct start 1: Soft start	0~1	0	×
15.05	Add pump delay time	The delay time used for adding the pump.	0.0 ~ 3600.0s	10.0	○
15.06	Reduce pump delay time	The delay time used for reduce the pump.	0.0 ~ 3600.0s	10.0	○
15.07	Sensor range	If 08.01=5, select the sensor range (15.07) and the given pressure (15.08) according to the field conditions.	0.00 ~ 60.00 (MPa、Kg)	10.00	○
15.08	Pressure setting		0.00 ~ 【 15.07 】 (MPa、Kg)	5.00	○

016 Group-Photovoltaic water pump MPPT parameters

HV100 Series High Performance Current Vector Inverter

Function code	Name	Content	Setting range	Factory	Alteration
16.00	Lack of water detect time	If the bus voltage (d-12) is higher than the set value of MPPT high working voltage (16.02), it will run at the maximum frequency; if it is lower than the set value of MPPT high working voltage (16.01), it will be operated according to (bus voltage/MPPT high point operating voltage) * Maximum frequency operation. If the bus voltage reaches the MPPT low point operating voltage (16.01), it will run at the lowest water output frequency (16.04). If the inverter runs above the lowest water frequency and the output current is less than Motor no-load current * Photovoltaic water pump water shortage detection current corresponds to the ratio of no-load current (16.03). After the photovoltaic water pump water shortage detection time (16.00), the inverter reports water shortage fault E-32.	0~250s	10	○
16.01	MPPT low point operating Voltage		0 ~ MPPT High operating voltage	350/200V	○
16.02	MPPT high point operating Voltage		【 16.01 】 ~ 1000 / 【 16.01 】 ~ 500	537/311V	○
16.03	Photovoltaic pump water shortage detection current corresponds to the ratio of no-load current		80.0 ~ 300.0%* High operating voltage	150.0	○
16.04	Minimum operating frequency of photovoltaic water pump		0.00Hz ~ Upper limit frequency	20.00	○

d-xx Group-Monitoring parameter group and fault record

Function code	Name	Setting range	Factory	Alteration
d-00	Output frequency	0.00~Max output frequency 【00.13】	0	◆
d-01	Settings frequency	0.00~Max output frequency 【00.13】	0	◆
d-02	Motor estimated frequency	0.00~Max output frequency【00.13】Note: the running frequency of the motor is calculated from the estimated speed of the motor	0	◆
d-03	Main frequency	0.00~Max output frequency 【00.13】	0	◆
d-04	Auxiliary frequency	0.00~Max output frequency 【00.13】	0	◆
d-05	Output current	0.0~6553.5A	0	◆
d-06	Output voltage	0~999V	0	◆
d-07	Output Torque	-200.0~+200.0%	0	◆
d-08	Motor rotation speed(rpm)	0~36000 (rpm)	0	◆
d-09	Motor power factor	0.00~1.00	0	◆
d-10	Running line speed(m/s)	0.01~655.35(m/s)	0	◆
d-11	Setting line speed(m/s)	0.01~655.35(m/s)	0	◆
d-12	DC bus voltage(V)	0~999V	0	◆
d-13	Input voltage(V)	0~999V	0	◆
d-14	PID setting value(V)	0.00~10.00V	0	◆
d-15	PID feedback value(V)	0.00~10.00V	0	◆
d-16	Analog input AI1(V/mA)	0.00~10.00V	0	◆
d-17	Analog input AI2(V)	0.00~10.00V	0	◆
d-18	Pulse frequency input (KHz)	0.00~50.00kHz	0	◆
d-19	Analog output AO1(V/mA)	0.00~10.00V	0	◆
d-20	Analog output AO2(V)	0.00~10.00V	0	◆
d-21	Input terminal status	0 ~ 7th Note: After expanding to binary, it means HDI/DI6/DI5/DI4/DI3/DI2/DI1 from high to low	0	◆
d-22	Output terminal status	0 ~ FH Note: After expanding to binary, it means R2/R1/Y2/Y1 from high to low	0	◆
d-23	Operation status of frequency converter	0~FFFFH BIT0: Start/Stop BIT1: Forward/Reverse BIT2: Zero speed operation BIT3: Reserved BIT4: Acceleration BIT5: Deceleration BIT6: Constant speed BIT7: Pre-excitation BIT8: Motor parameter tuning BIT9: Over current limiting BIT10: Over voltage limiting	0	◆

HV100 Series High Performance Current Vector Inverter

		BIT11: Torque limiting BIT12: Speed limiting BIT13: Speed control BIT14: Torque control BIT15: Reserved		
d-24	Multi segment speed mode,current segment number	0~15	0	◆
d-25	Pulse frequency output(Hz)	0~50000Hz	0	◆
d-26	Reserved	—	0	◆
d-27	Current count	0~65535	0	◆
d-28	Set count value	0~65535	0	◆
d-29	Current timing value(S)	0~65535S	0	◆
d-30	Setting timing value(S)	0~65535S	0	◆
d-31	Current length	0.000~65.535(KM)	0	◆
d-32	Setting length	0.000~65.535(KM)	0	◆
d-33	Radiator temperature1	0.0℃~+110.0℃	0	◆
d-34	Radiator temperature2	0.0℃~+110.0℃	0	◆
d-35	Accumulated running time of the machine(h)	0~65535H	0	◆
d-36	Accumulated power-on time of the machine(h)	0~65535H	0	◆
d-37	Accumulated running time of the FAN(h)	0~65535H	0	◆
d-38	Accumulated electricity consumption (Low position)	0~9999KWH	0	◆
d-39	Accumulated electricity consumption (High position)	0~9999KWH (*10000)	0	◆
d-40	PID Pressure feedback	0.00~60.00 (MPa, Kg)	0.00	◆
d-41	Output frequency	0.0~6553.5KW	0.0	◆
d-42	PID Pressure setting	0.00~60.00 (MPa, Kg)	0.00	◆
d-48	4th fault type from last	0~34	0	◆
d-49	3rd fault type from last	0~34	0	◆
d-50	2nd fault type from last	0~34	0	◆
d-51	Latest fault type	0~34	0	◆
d-52	Operating frequency at latest fault	0.00~【00.13】 Upper limit frequency	0	◆
d-53	Output current at latest fault	0.0~6553.5A	0	◆
d-54	DC bus voltage at latest fault	0~999V	0	◆
d-55	DI status at latest fault	0~7FH Note: after expanding to binary, it means HDI/DI6/DI5/DI4/DI3/DI2/DI1 from high to low	0	◆
d-56	DO status at latest fault	0~FH Note: After expanding to binary, it means R2/R1/Y2/Y1 from high to low	0	◆
d-57	Inverter status at latest fault	0~FFFFH	0	◆

Chapter VII Description of Function Parameters

000 group-basic operating parameters

00.00	LCD language (only valid for LCD keypad)	
	0~2	0

- 0: Chinese
 1: English
 2: Reservation

00.01	Functional macro definition	
	0~20	0

- 0: General model
 1: Single pump constant pressure water supply mode
 2: One inverter with two working (1 variable frequency pump +2 power frequency pumps) water supply mode
 3: Three-pump cycle soft start (3 variable frequency pumps) water supply mode
 4: Photovoltaic pump water supply mode
 5: CNC machine tool control mode
 6: Fire patrol mode
 7: EPS power mode
 8~20: Reservation

Note: Initialize parameters first, and then set macro functions. Options 2 and 3 are detailed in the description of water supply parameters.

00.02	Control mode	
	0~4	Model setting

0: Common V/F control

When more than one motor needs to be driven by a single inverter, and when the motor parameter self-learning cannot be carried out correctly or the parameters of the controlled motor cannot be obtained by other means, the control mode is selected. This control mode is the most commonly used motor control mode, which can be used in any occasion with low requirements on motor control performance.

1: Advanced V/F control

This control mode introduces the idea of flux closed-loop control, which can greatly improve the torque response of motor control in the whole frequency band and enhance the torque output ability of motor at low frequency, and at the same time, it is not too sensitive to motor parameters like field-oriented vector control. This control mode is especially suitable for some occasions with certain requirements on starting torque (such as wire drawing machine, ball mill, etc.)

2. SVC mode (SVC) -Open-loop current vector control (motor parameter sensitive mode)

The real current vector control mode has not only the high torque output performance of magnetic flux control mode, but also the flexible torque output effect, which can be described as a combination of rigidity and flexibility. However, this control mode is sensitive to motor parameters, so it is best to enable dynamic self-learning of motor parameters before using it, otherwise the effect is not good.

3: Reserved

4. Separate V/F control

In this control mode, the output voltage and frequency of the inverter can be controlled independently, instead of simply satisfying the constant V/F relationship, it can generally be used in the fields of variable frequency power supply, EPS and so on.

Note: The factory default is 1 for below 55KW and 0 for above 75KW.

00.03	Run command channel selection	
	0~2	0

This function code selects the physical channel where the inverter accepts operation commands such as running and stopping.

0: The operation panel runs the command channel

Operation control is implemented by the (RUN), (STOP/RESET), (M-FUNC) and other keys on the operation panel.

1: Terminal operation command channel

HV100 Series High Performance Current Vector Inverter

Operation control is implemented by multi-function terminals defined as FWD, REV, JOG forward rotation, JOG reverse rotation and other functions.

2: Communication operation command channel

Operation control is implemented by the upper controller through communication.

⚠Notes:

Even in the running process, by modifying the set value of the function code, the running command channel can be changed. Please set it carefully!

00.04	Selection of main frequency source A	
	0~11	9



0: Digital setting 1 (press keyboard key , encoder+00.10)

The  initial value of frequency setting is 00.09, which can be adjusted by using operation panel key or digital encoder. The modified frequency value will be stored in 00.09 after power failure (if you want this frequency not to be stored, you can set 00.07 to 1.

1: Digital setting 2(UP/DOWN terminal +00.10)

The initial value of frequency setting is 00.10, and the operating frequency is changed by the on-off of multifunctional terminals externally defined as UP/DOWN function (see 07 Group X terminal frequency increasing and decreasing item function number for details). When the UP terminal and COM terminal are closed, the frequency rises; When the DOWN terminal and COM terminal are closed, the frequency drops; The frequency remains unchanged when the UP/DOWN terminal is closed or disconnected from the COM terminal at the same time. If frequency power-down storage is set, the modified frequency value will be stored in 00.10 after power-down. The rate at which the UP/DOWN terminal modifies the operating frequency can be set by function code 07.12.

📖Tips:

Whether  it is panel key adjustment or terminal UP/DOWN adjustment, the set value is superimposed with an adjustment amount on the basis of 00.09 or 00.10, and the final frequency output value is from the lower limit frequency to the maximum output frequency. The adjustment amount of terminal UP/DOWN adjustment can be cleared by selecting 0 for the UP/DOWN terminal frequency through X terminal. The  adjustment  amount of the panel can also be cleared by selecting the clear key frequency setting.

2: Digital setting 3 (communication setting)

Change the set frequency through the serial port frequency setting command. See Group 011 communication parameters for details.

3: AI1 analog setting (0 ~ 10V/20mA)

The frequency setting is determined by the analog voltage/current of AI1 terminal, and the input range is:

See the definition of function 06.00 ~ 06.05 for the related setting of DC 0 ~ 10V/20mA.

4: AI2 analog setting (0 ~ 10V)

The frequency setting is determined by the analog voltage/current of AI1 terminal, and the input range is:

See definition of function code 06.06 ~ 06.11 for related setting of DC 0 ~ 10 V.

5: Pulse setting(0~50Hz)

The frequency setting is determined by the terminal pulse frequency (it can only be input by DI6, see 07.05 definition), and the input pulse signal specification: the high level range is 15 ~ 30V; The frequency range is 0 ~ 50khz. See the definition of function code 06.15 ~ 06.20 for related settings.

6: Simple PLC

To select the given frequency mode of simple PLC, it is necessary to set the function code 09.00 ~ 09.05; Function codes 09.06 ~ 09.21 are used to determine the operating frequency of each stage of PLC, and function codes 09.22 ~ 09.53 respectively define the acceleration and deceleration time and operation time of each stage of PLC.

7: Multi-speed settings

Choose this frequency setting mode, and the inverter runs in multi-speed mode. It is necessary to set F7 group "X terminal as multi-speed selection"and 009 groups of "multi-speed frequency" function codes to determine the corresponding relationship between a given number of multi-speed segments and a given frequency.

8: PID control

If this frequency setting mode is selected, the operation mode of inverter is process PID control. At this time, 008 sets of process PID parameters and analog given and pulse given related function codes need to be set. Operating frequency of inverter is the frequency value after PID action. Please refer to the detailed description of 008 group functions for specific settings.

9: Keyboard potentiometer setting

The operating frequency is adjusted by operating the potentiometer on the keyboard, and the adjusting frequency range of the potentiometer is fixed from 0 to the maximum output frequency [00.12].

10: MPPT given (Solar water pump)

11: Potentiometer

HV100 Series High Performance Current Vector Inverter

00.05	Selection of auxiliary frequency source B	
	0 ~ 11 (same as main frequency channel selection)	3

- 0: digital setting 1 (press keyboard key , encoder+00.10)
 1: digital setting 2(UP/DOWN terminal adjustment)
 2: digital setting 3 (communication setting)
 3: AI1 analog setting (0 ~ 10V/20mA)
 4: AI2 analog setting (0 ~ 10V)
 5: Pulse setting (0 ~ 50 kHz)
 6: Simple PLC
 7: Multi-speed settings
 8: PID control
 9: Keyboard potentiometer setting(compatible encoder)
 10: MPPT given (solar water pump)
 11: Keyboard potentiometer

All meanings of auxiliary frequency given channel are the same as those of main frequency given channel, please refer to 00.04 for detailed description.

00.06	Frequency source given way	
	0~9	0

0: main frequency source A

1: $A + K * B$

The main frequency, given channel a frequency, and the auxiliary frequency, given channel b frequency, are multiplied by the weight coefficient k, and then the two frequencies are added as the final given frequency of the inverter.

2: $A - K * B$

The main frequency, given channel A frequency, and the auxiliary frequency, given channel B frequency, are multiplied by the weight coefficient k, and then the two frequencies are subtracted as the final given frequency of the inverter.

3: $| A - K * B |$

The main frequency, given channel A frequency, and the auxiliary frequency, given channel B frequency, are multiplied by the coefficient k, and then the two frequencies are subtracted as the final given frequency of the inverter.

4: MAX (A , K * B)

After multiplying the given channel A frequency of the main frequency and the given channel B frequency of the auxiliary frequency by the weight coefficient K, compare the two frequencies and take the larger one as the final given frequency of the inverter.

5: MIN (A , K * B)

After multiplying the given channel A frequency of the main frequency and the given channel B frequency of the auxiliary frequency by the weight coefficient K, compare the two frequencies, and take the smaller one as the final given frequency of the inverter.

6: switch A to $K * B$

This function is used in conjunction with the 29th function item of DI1~HDI function in F7 group parameters. When 00.06=6 and the function of X terminal is selected as 29, the X terminal is valid and the given frequency source is switched from A to $K * B$; X terminal is invalid, the frequency source returns to a ..

7: Switch between A and ($A + K * B$)

This function is used in conjunction with function item No.30 of terminal DI1 ~ X8 function in F7 group parameters. When 00.06=7 and X terminal function is selected as 30, the X terminal is valid and the frequency given source is switched from A to $(A + K * B)$; When the X terminal is invalid, the frequency source returns to A.

8: Switch between A and ($A - K * B$)

This function is used in conjunction with function item No.31 of terminal DI1 ~ x8 function in F7 group parameters. When 00.06=8 and X terminal function is selected as 31, the X terminal is valid and the frequency given source is switched from A to $(A - K * B)$; When the X terminal is invalid, the frequency source returns to A.

Notes:

The given frequency is still limited by the starting frequency, upper and lower frequencies, etc. The positive and negative frequency determines the running direction of the inverter.

Where K is the weight coefficient of auxiliary frequency source b, please refer to the detailed description of 00.11 function code for specific settings.

00.07	Digital setting 1	
	0000 ~ 1111	0000

LED single digit: power down store

0: store

HV100 Series High Performance Current Vector Inverter

When the inverter is powered on, the panel frequency increment is initialized to the value saved in EEPROM during the last power failure.

1: not store

When the inverter is powered on, the panel frequency increment is initialized to 0.

LED 10-digit: stop keep

0: keep

When the inverter stops, the frequency set value is the final modified value.

1: Stop not keep

When the inverter stops, the set frequency is restored to 00.09.

LED 100-digit:  key. Negative frequency adjustment

0: invalid

1: valid

When the selection is valid, the positive and negative adjustment of frequency can be realized by operating keyboard

keys. 

00.08	Digital setting 2	
	0000 ~ 1111	0000

LED single digit: power down store

0: store

When the inverter is powered on, the terminal frequency increment is initialized to the value saved in EEPROM during the last power failure.

1: not store

When the inverter is powered on, the terminal frequency increment is initialized to 0.

LED 10-digit: stop keep

0: keep

When the inverter stops, the frequency set value is the final modified value.

1: Stop not keep When the inverter is not stopped, the set frequency is restored to 00.10.

LED 100-digit: UP/DOWN negative frequency regulation

0: invalid

1: valid

Select valid, terminal UP/DOWN can realize the positive and negative adjustment of frequency.

00.09	Frequency source digital given 1 setting	
	0.00Hz ~ 【00.13】 upper limit frequency	50.00

When the frequency channel is defined as digital given 1 (the main frequency source is 0 and the auxiliary frequency source is 0), this function parameter is the initial set frequency given by the digital frequency of the inverter panel.

00.10	Frequency source digital given 2 setting	
	0.00Hz ~ 【00.13】 upper limit frequency	50.00

When the frequency channel is defined as digital given 2 (the main frequency source and auxiliary frequency source are 1), this function parameter is the initial set frequency of the frequency given by the inverter terminal.

00.11	Setting of auxiliary frequency source weight coefficient K	
	0.01 ~ 10.00	1.00

K is the weight coefficient of auxiliary frequency source

00.12	Max output frequency	
	Low frequency band: max {50.00, [00.13]} ~ 300.00; high frequency band: max {50.0, [00.13]} ~ 300.0	50.00

00.13	Upper limit frequency	
	【00.14】 ~ 【00.12】	50.00
00.14	Lower limit frequency	
	0.00Hz ~ 【00.13】	0.00

HV100 Series High Performance Current Vector Inverter

The maximum output frequency is the highest frequency allowed by the inverter, which is the benchmark for setting acceleration and deceleration time, as shown in the figure f_{max} below. The basic operating frequency is the minimum frequency corresponding to the highest voltage output by the inverter, which is generally the rated frequency of the motor, as shown in the figure below. The maximum output voltage V_{max} is the corresponding output voltage when the inverter outputs the basic operating frequency, which is generally the rated voltage of the motor; V_{max} : as shown in the following figure; f_H and f_L are defined as upper limit frequency and lower limit frequency respectively, as shown in Figure 00-1:

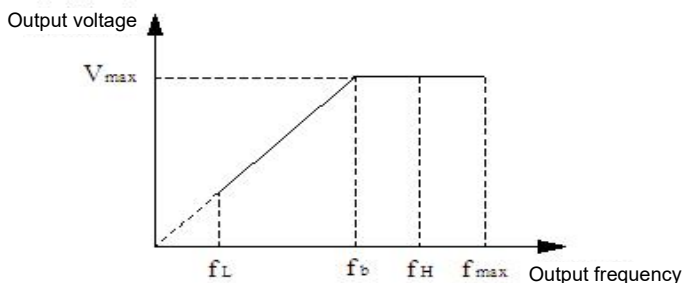

Figure 00-1 Schematic diagram of voltage and frequency

⚠Notes:

1. The maximum output frequency, upper limit frequency and lower limit frequency should be carefully set according to the nameplate parameters and operating conditions of the actual controlled motor, otherwise the equipment may be damaged.
2. The limit range of upper frequency is valid for JOG operation, while the limit range of lower frequency is invalid for JOG operation.
3. In addition to the upper limit frequency and the lower limit frequency, the output frequency of the inverter during operation is also limited by the set values of parameters such as starting frequency, starting frequency of DC braking during shutdown and jumping frequency.
4. The relationship among maximum output frequency, upper limit frequency and lower limit frequency is shown in the above figure 00-1. Please pay attention to the order of magnitude when setting.
5. The upper and lower limit frequencies are used to limit the actual output frequency of the motor. If the set frequency is higher than the upper limit frequency, it will run at the upper limit frequency; Run at the lower limit frequency if the set frequency is lower than the lower limit frequency (the running state when the set frequency is lower than the lower limit frequency is also related to the setting of function code 01.31); If the set frequency is less than the starting frequency, it will run at zero frequency when starting.

00.15	Frequency output mode	
	0000~011	0000

LED single digit: high and low frequency mode selection

0: Low frequency mode (0.00~300.00HZ)

1: High frequency mode (0.0~300.0HZ)

LED 10-digit: acceleration and deceleration reference selection

0: Maximum output frequency as the reference

1: Target output frequency as the reference

LED 100-digit: reserved

LED 1000-digit: reserved

The high frequency mode is only effective for V/F control

00.16	Acceleration time 1	
	0.1~3600.0S	Model setting
00.17	Deceleration time 1	
	0.1~3600.0S	Model setting

The acceleration time refers to the time required for the inverter to accelerate from zero frequency to the maximum output frequency, as shown in the figure below at t_1 . Deceleration time refers to the time required for the inverter to decelerate from the maximum output frequency to zero frequency, t_2 as shown in the figure below.

There are four groups of acceleration and deceleration time parameters of this series of inverters, and the acceleration and deceleration time of the other three groups is defined in the function codes 01.13 ~ 01.18. The factory default acceleration and deceleration time is determined by the model. If you want to select other acceleration and deceleration time groups, please select them through the multi-function terminal (please refer to the function codes 07.00 ~ 07.06). The acceleration and deceleration time of JOG operation are defined separately in 01.22 and 01.23.

HV100 Series High Performance Current Vector Inverter

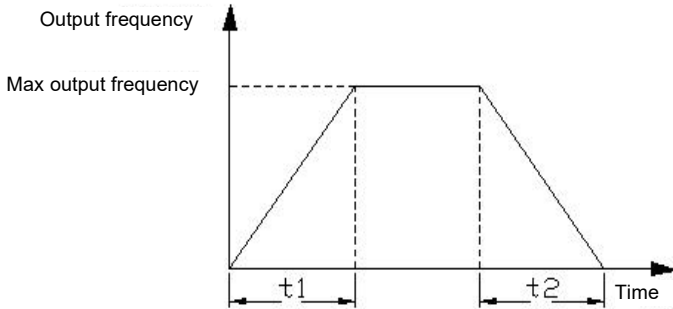

Figure 00-2 Schematic diagram of acceleration time and deceleration time

00.18	Running direction setting	
	0~2	0

0: Forward direction

When this mode is selected, the actual output phase sequence of the inverter is consistent with the default phase sequence of the system. At this time, the keys RUN on the panel and FWD terminal functions become forward control.

1: Reverse direction

When this mode is selected, the actual output phase sequence of the inverter will be opposite to the default phase sequence of the system. At this time, the functions of keys RUN and FWD terminals on the panel are changed to reverse control.

2: Forbidden reverse operation

In any case, the motor can only run forward. This function is suitable for situations where reverse operation may bring danger or property loss. Given the reverse command, the inverter runs at zero speed.

□□ Tips:

This function code setting is valid for running direction control of all running command channels.

00.19	Carrier frequency setting	
	1.0~16.0KHz	Model setting
0.4~4.0KW	6.0KHz	1.0~16.0KHz
5.5~30KW	4.5KHz	1.0~16.0KHz
37~132KW	3.0KHz	1.0~10.0KHz
160~630KW	1.8KHz	1.0~5.0 KHz

This function code is used to set the carrier frequency of PWM wave output by inverter. The carrier frequency will affect the noise when the motor is running, and the carrier frequency can be appropriately increased to meet the requirements when silent operation is required. However, increasing the carrier frequency will increase the calorific value of the inverter and the electromagnetic interference to the outside world.

When the carrier frequency exceeds the factory set value, the inverter needs to be derated. Generally, the inverter current needs to be derated by about 5% for every 1KHz increase of download wave.

00.20	User password	
	0~65535	0

The user password setting function is used to prohibit unauthorized personnel from consulting and modifying function parameters.

In order to avoid misoperation, user passwords less than 10 are invalid.

When setting the user password, enter any number not less than 10, press the key ENTER to confirm, and the password will take effect automatically after 3 minutes.

When you need to change the password, select the 00.20 function code, press the key ENTER to enter the password verification state, enter the modification state after the password verification is successful, enter a new password, press the key ENTER to confirm, and the password will automatically take effect after 3 minutes.

Please keep your password properly. If you forget it, please ask the manufacturer for service.

□□ Tips:

Please keep the password, and consult the manufacturer if it is lost.

HV100 Series High Performance Current Vector Inverter

Group 01-start-stop control parameters

01.00	Starting mode	
	0~2	0

0: Starting frequency starting

Start according to the set starting frequency (01.01) and starting frequency holding time (01.02).

1: DC braking+starting frequency starting

First DC brake (refer to 01.03 and 01.04), and then start according to mode 0.

2: Speed tracking starting

In case of power-on after power failure, if the starting conditions are met, the inverter will automatically start running in the mode of speed tracking after waiting for the time defined in 12.15.

01.01	Starting frequency	
	0.00~50.00Hz	1.00
01.02	Starting frequency holding time	
	0.0~600.0s	0.0

Starting frequency refers to the initial frequency when the inverter starts. As shown in the figure f_s below, for some systems with large starting torque, setting reasonable starting frequency can validly overcome the problem of starting difficulty. The starting frequency holding time refers to the time that the inverter keeps running at the starting frequency during the starting process, as shown in the figure below at t_1 . Schematic diagram of startup frequency is as follows:

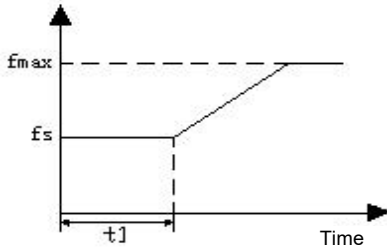

Figure 01-1 Diagram of Start Frequency

Tips:

1. The start frequency is not limited by the lower limit frequency. The JOG frequency is not limited by the lower limit frequency but is limited by the starting frequency.
2. When 00.15=1 (high frequency mode), the upper limit of starting frequency is 500.0Hz.

01.03	Starting DC braking current	
	0.0 ~ 150.0% * rated current of motor	0.0%
01.04	Starting DC braking time	
	0.0~100.0s	0.0

The starting DC braking current is set as a percentage relative to the rated output current of the inverter. When starting DC braking time is 0.0s, there is no DC braking process. As shown in the figure below:

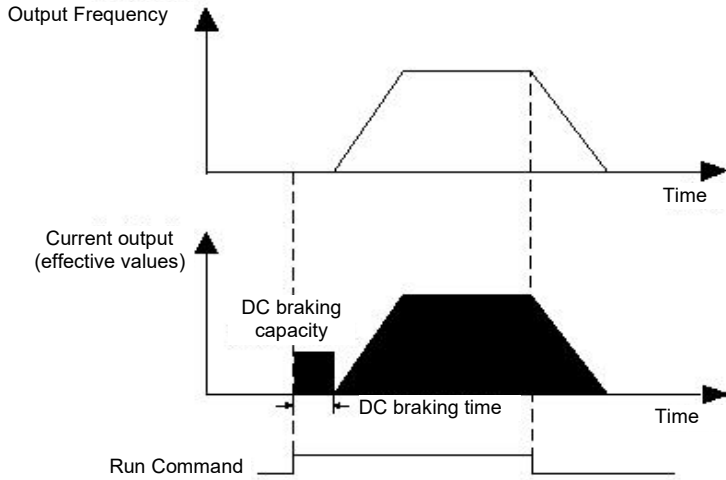

Figure 01-2 Diagram of starting DC brake

01.05	Acceleration / deceleration mode	
	0~1	0

0: Straight line acceleration / deceleration

The relationship between output frequency and time increases or decreases according to a constant slope, as shown in the following figure.

1: S-curve acceleration / deceleration

The relationship between output frequency and time increases or decreases according to the S-shaped curve. When acceleration starts and speed arrives, and when deceleration starts and speed arrives, the speed set value is in the S-shaped curve state. This can make acceleration and deceleration smooth and reduce the impact on the load. S-curve acceleration and deceleration mode is suitable for the start and stop of transporting and transferring loads, such as elevators and conveyor belts. As shown in the figure below: t_1 is acceleration time, t_2 is deceleration time, t_s is start time of S curve, t_e is end time of S curve, $01.06 = t_s/t_1$, $01.07 = t_e/t_2$.

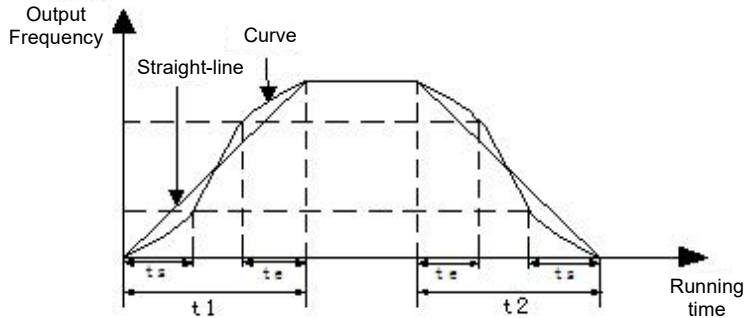

Figure 01-3 Schematic diagram of acceleration and deceleration of straight line and S curve

01.06	Time proportion at the beginning of S curve	
	10.0~50.0%	20.0%
01.07	Time proportion at the end of S curve	
	10.0~50.0%	20.0%

See the S-curve acceleration and deceleration term in 01.05.

01.08	Stop mode	
	0~1	0

0: deceleration to stop

HV100 Series High Performance Current Vector Inverter

After receiving the shutdown command, the inverter gradually reduces the output frequency according to the deceleration time, and stops after the frequency drops to zero. If the shutdown DC braking function is valid, the DC braking process will be executed after reaching the shutdown DC braking start frequency (according to 01.09 setting, a shutdown DC braking waiting time may be required), and then the shutdown will be performed.

1: Free stop

After receiving the shutdown command, the inverter immediately terminates the output, and the load stops freely according to the mechanical inertia.

01.09	Start frequency of DC braking during stop	0.00
	0.00 ~ [00.13] upper limit frequency	
01.10	Waiting time for DC braking during stop	0.0
	0.0~100.0s	
01.11	DC braking current during stop	0.0%
	0.0 ~ 150.0% * rated current of motor	
01.12	Time for DC braking during stop	0.0
	0.0: DC brake does not operate	
	0.1~100.0s	

The set value of DC braking current during shutdown is a percentage relative to the rated current of the inverter. When the stop braking time is 0.0s, there is no DC braking process. As shown in the figure below:

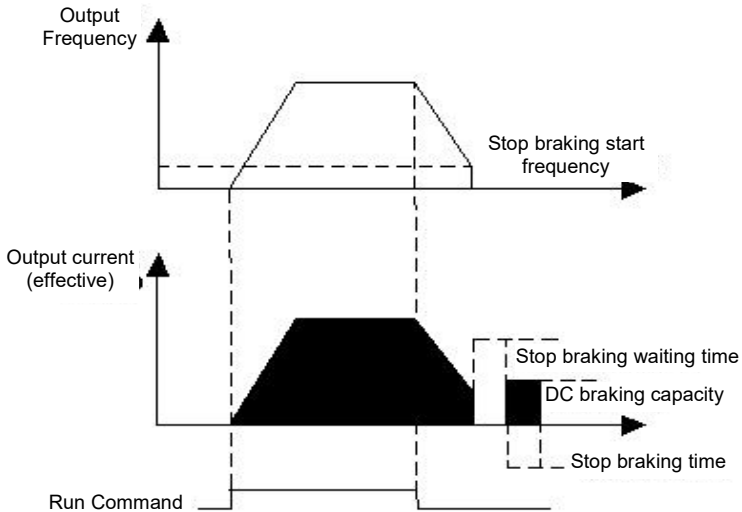

Figure 01-4 Diagram of shutdown DC brake

01.13	Acceleration time 2	Type setting
	0.1~3600.0	
01.14	Deceleration time 2	Type setting
	0.1~3600.0	
01.15	Acceleration time 3	Type setting
	0.1~3600.0	
01.16	Deceleration time 3	Type setting
	0.1~3600.0	
01.17	Acceleration time 4	Type setting
	0.1~3600.0	
01.18	Deceleration time 4	Type setting
	0.1~3600.0	

Four groups of acceleration and deceleration time can be defined and can be controlled by different groups of terminals. To select the acceleration and deceleration time 1 ~ 4 during the operation of the inverter, please refer to the definition of the terminal function of increasing deceleration time 07.00 ~ 07.06.



Acceleration and deceleration time 1 is defined in 00.16 and 00.17.

01.19	Selection of acceleration and deceleration time unit	
	0~2	0

- 0: Second
- 1: Minute
- 2: 0.1 second

This function code defines the dimension of acceleration and deceleration time.

01.20	Jog forward running frequency setting	
	0.00 ~ [00.13] upper limit frequency	5.00
01.21	Jog reverse running frequency setting	
	0.00 ~ [00.13] upper limit frequency	5.00
01.22	Jog acceleration time	
	0.1~3600.0s	Type setting
01.23	Jog deceleration time	
	0.1~3600.0s	Type setting
01.24	Jog Interval time	
	0.1~100.0s	0.1

01.20 ~ 01.24 defines relevant parameters during jog operation. As shown in fig. 01-5, t_1 and t_3 are the actual jog acceleration and deceleration time; t_2 is JOG time; t_4 is jog interval time (01.24); f_1 is the running frequency of forward jog (01.20); f_2 is the reverse jog operation frequency (01.21). The actual jog acceleration time t_1 is determined according to the following formula:

$$t_1 = 01.20 * 01.22 / 00.12$$

Similarly, the actual jog deceleration time t_3 can be determined as follows:

$$t_3 = 01.21 * 01.23 / 00.12$$

Where 00.12 is the maximum output frequency.

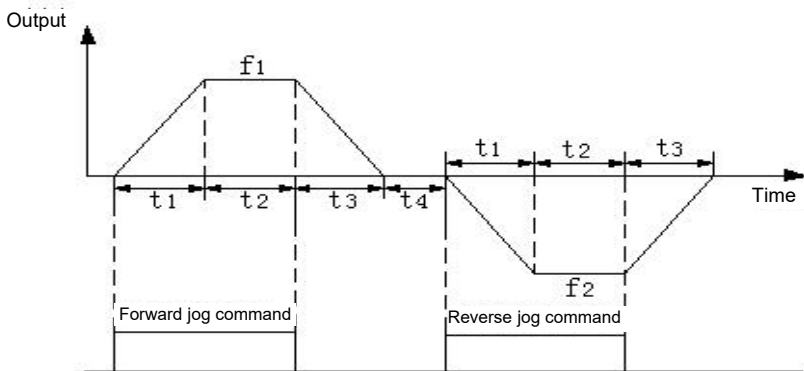

Figure 01-5 JOG Operation Diagram

01.25	Jump frequency 1	
	0.00 ~ upper limit frequency	0.00
01.26	Jump frequency 1 range	
	0.00 ~ upper limit frequency	0.00
01.27	Jump frequency 2	
	0.00 ~ upper limit frequency	0.00
01.28	Jump frequency 2 range	
	0.00 ~ upper limit frequency	0.00
01.29	Jump frequency 3	
	0.00 ~ upper limit frequency	0.00
01.30	Jump frequency 3 range	
	0.00 ~ upper limit frequency	0.00

HV100 Series High Performance Current Vector Inverter

The above function codes are functions set to make the output frequency of inverter avoid the resonance frequency point of mechanical load. The set frequency of the inverter can be given by jumping near some frequency points according to the following figure. Its specific meaning is that the frequency of the inverter will never run stably within the jumping frequency range, but will pass through this range during acceleration and deceleration.

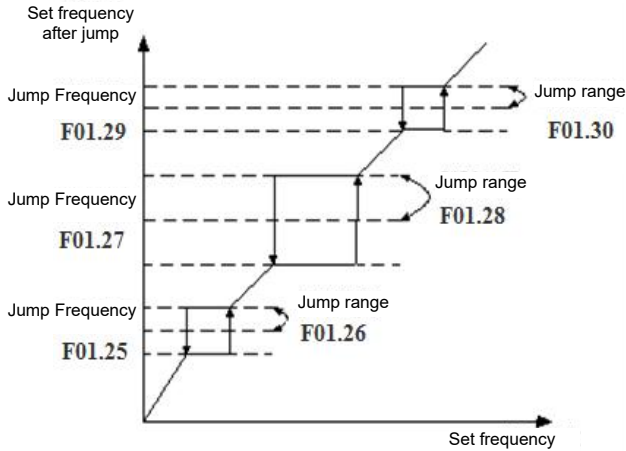

Figure 01-6 Diagram of Jump Frequency

01.31	Action when the set frequency is lower than the lower limit frequency	0
	0~2	

0: Run at the lower limit frequency.

When the set frequency is lower than the set value of the lower limit frequency (00.14), the inverter operates at the lower limit frequency.

1: Zero frequency operation after delay time

When the set frequency is lower than the set value of the lower limit frequency (00.14), the inverter runs at zero frequency after a delay time (01.32).

2: Shutdown after a delay time

When the set frequency is lower than the set value of the lower limit frequency (00.14), the inverter stops after a delay time (01.32).

01.32	Stop delay time when frequency is lower than lower limit frequency (simple dormancy)	10.0
	0.0~3600.0s	

See 01.31 parameter description for details.

01.33	Zero frequency braking current	0.0
	0.0~150.0%	

This parameter is the percentage of the rated current of the motor.

01.34	Forward and reverse dead zone time	0.0
	0.0~100.0s	

The waiting time for the inverter to transition from forward operation to reverse operation, or from reverse operation to forward operation, as shown in the t1 figure below. The waiting frequency of switching transition is also related to the setting of 01.35.

HV100 Series High Performance Current Vector Inverter

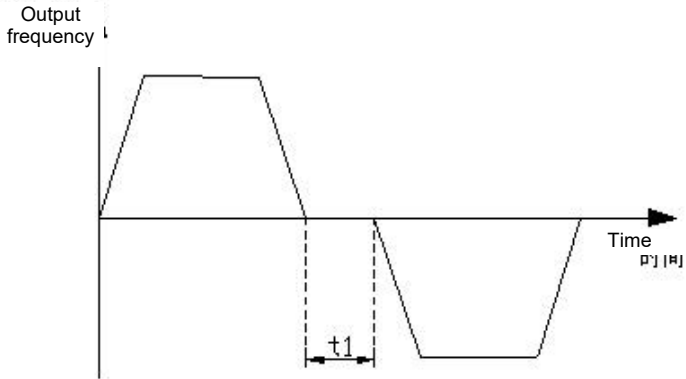

Figure 01-7 Schematic diagram of forward and reverse dead time

01.35	Forward and reverse switching mode	0
	0~1	

0: Over 0Hz frequency switching
1: Over start frequency switching

01.36	Emergency stop standby deceleration time	1.0
	0.1~3600.0S	

For details, please refer to the function description of No. 10 in the digital input terminal (07.00~07.06).

01.37	Current holding time for DC braking during shutdown	0.0
	0.0~100.0S	

002 Group- Motor parameters

02.00	Selection of motor type	0
	0~1	

0: AC asynchronous motor 1: reserved

02.01	Motor rated Power	
	0.4~999.9KW	Model setting
02.02	Motor rated frequency	50.00
	0.01Hz~ 【00.12】 Max output frequency	
02.03	Motor rated speed	Model setting
	0~60000RPM	
02.04	Motor rated voltage	Model setting
	0~999V	
02.05	Motor rated current	Model setting
	0.1~6553.5A	

⚠ Notes:

The above function codes must be set according to the motor nameplate parameters. Please configure the corresponding motor according to the power of the inverter. If the power difference is too large, the control performance of the inverter will obviously decrease.

02.06	Stator resistance of asynchronous motor	
	0.01~20.000Ω	Model setting
02.07	Rotor resistance of asynchronous motor	
	0.01~20.000Ω	Model setting

HV100 Series High Performance Current Vector Inverter

02.08	Inductance of stator and rotor of asynchronous motor	
	0.1~6553.5mH	Model setting
02.09	Mutual inductance between stator and rotor of asynchronous motor	
	0.1~6553.5mH	Model setting
02.10	No-load current of asynchronous motor	
	0.01~655.35A	Model setting

The specific meanings of the above motor parameters are shown in Figure F2-1.

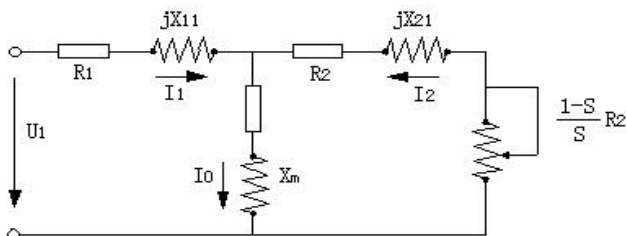

Fig. F2-1 steady-state equivalent circuit diagram of asynchronous motor

R_1 , jx_{11} , R_2 , jx_{21} , X_m and I_0 in Figure F2-1 respectively represent stator resistance, stator leakage inductance, rotor resistance, rotor leakage inductance, mutual inductance and no-load current.

If the motor is tuned, the set values from 02.06 to 02.10 will be updated after the tuning is finished.

After the rated power of asynchronous motor is changed to 02.01, the parameters from 02.03 to 02.10 are automatically updated to the default parameters of asynchronous motor with corresponding power (02.02 is the rated frequency of motor, which is not within the range of default parameters of asynchronous motor and needs to be set by the user according to the nameplate).

02.11~	Reserved	
02.15	Reserved	0
02.16	Motor tuning selection	
	0~3	0

0: No action

1: Static tuning

Parameter measurement mode when the motor is in a static state, which is suitable for situations where the motor and the load cannot be separated.

2: No-load Complete tuning

The complete parameter measurement mode of the motor is adopted as far as possible when the motor can be separated from the load.



Tips:

1: When 02.16 is set to 2, if there is over current and tuning fault during tuning, It is necessary to check whether the output is out of phase and whether the models match

2: When 02.16 is set to 2, When complete tuning is carried out, the motor shaft should be separated from the load, and the complete tuning of the motor with load is prohibited;

3: Before starting the motor parameter tuning, make sure that the motor is in a stopped state, otherwise the tuning cannot be performed normally.

4: In some occasions (such as the motor can not be separated from the load, etc.), when complete tuning is inconvenient or the user has low requirements for motor control performance, static tuning can be performed.

5: If tuning is impossible and the user already knows the accurate motor parameters, the user can directly input the motor nameplate parameters (02.01 ~ 02.14), and the superior performance of the inverter can still be exerted. The tuning is unsuccessful, protect the action and display E-21.

HV100 Series High Performance Current Vector Inverter

02.17	Pre-excitation holding time of asynchronous motor		Model setting
	0.00 ~ 10.00S		
	0.4 ~ 4.0KW	0.02S	
	5.5 ~ 30KW	0.05S	
	37 ~ 132KW	0.10S	
	160 ~ 630KW	0.20S	
Note: This parameter is invalid for VF control			

003 group- Reserved

004 group-Speed loop and torque control parameters

04.00	Speed loop (ASR1) proportional gain	1.000
	0.000 ~ 6.000	
04.01	Speed loop(ASR1) Integral time	1.000
	0.000 ~ 32.000S	
04.02	ASR1 filter time constant	0.000
	0.000 ~ 0.100S	
04.03	Switch low point frequency	5.00
	0.00Hz ~ 【04.07】	
04.04	Speed loop (ASR2) proportional gain	1.500
	0 ~ 6.000	
04.05	Speed loop(ASR2) Integral time	0.500
	0.00 ~ 32.000S	
04.06	ASR2 filter time constant	0.000
	0.000 ~ 0.100S	
04.07	Switch high point frequency	10.00
	04.03 ~ [00.13] upper limit frequency	

Function codes 04.00 ~ 04.07 are valid without PG vector control.

In vector control mode, the speed response characteristics of vector control are changed by setting the proportional gain p and integration time i of the speed regulator.

The composition of the speed regulator (ASR) is shown in Figure F4-1. In the figure, KP is the proportional gain P, TI is the integral time I ..

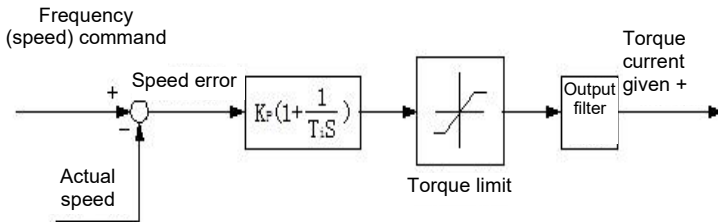

Fig. F4 -1 simplified diagram of speed regulator

04.08	Positive slip compensation coefficient of vector control (electric state)	100.0%
	50.0% ~ 200.0% * rated slip frequency	
04.09	Negative slip compensation coefficient of vector control (braking state)	100.0%
	50.0% ~ 200.0% * rated slip frequency	

Under the vector control mode, the above function code parameters are used to adjust the speed stability accuracy of the motor. When the motor is under heavy load and the speed is low, increase this parameter, otherwise decrease this parameter.

The positive slip coefficient compensates the speed when the motor slip is positive, whereas the negative slip coefficient compensates the speed when the motor slip is negative.

04.10	Selection of speed and torque control	0
	0 ~ 2	

0: Speed

When there is no PG current vector control, the control object is speed control.

1: Torque

Torque control is the control object without PG current vector control. Please refer to 04.12 ~ 04.24 for related parameter settings.

HV100 Series High Performance Current Vector Inverter

2. Condition effective (terminal switching)

The control object without PG current vector control is controlled by the switch input terminal (DI) defined as speed and torque control switching. Please refer to function description No.48 of 07 parameter group, DI terminal function.

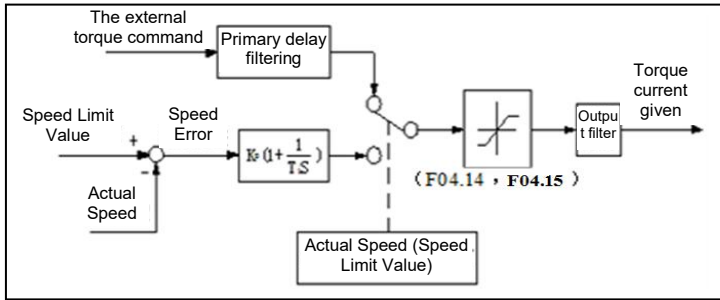

Fig. F4-2 simplified block diagram of torque control

04.11	Speed and torque switching delay	0.01~1.00S	0.05

This function code defines the delay time when switching torque and speed mode.

04.12	Torque command selection	0~3	0

This function code sets the torque given channel during torque control.

0: Keypad digit given

Torque commands are given by keypad digit. See 04.13 settings for setting values.

1: AI1

Torque command is set by analog input AI1. The positive and negative input of AI1 corresponds to the torque command value in the positive and negative directions.

When using this function, users need to set the physical quantity corresponding to AI1 input as torque instruction, and also set the corresponding curve of AI1 and the filtering time of AI1 input. Please refer to the description of function code 06.00 ~ 06.05.

2: AI2

Torque command is set by analog input AI1. The positive and negative input of AI1 corresponds to the torque command value in the positive and negative directions.

When using this function, users need to set the physical quantity corresponding to AI1 input as torque instruction, and also set the corresponding curve of AI1 and the filtering time of AI1 input. Please refer to the description of function code 06.06 ~ 06.11.

3: Communication given

Torque instruction is given by RS485 communication.

04.13	Keyboard digital setting torque	-200.0% ~ 200.0% * rated current of motor	0.0%

The set value of this function code corresponds to the torque instruction, and is selected as the torque set value given by keypad digit.

04.14	Speed limit channel selection 1 for torque control mode (forward direction)	0~2	0

This function code sets the forward speed limit channel during torque control.

0: Keypad digit given 1

See 04.16 Settings for details.

1: AI1

The forward speed limiting channel in torque control is given by AI1. Please refer to the description of function code 06.00 ~ 06.05.

2: AI2

The forward speed limiting channel during torque control is given by AI2. Please refer to the description of function code 06.06 ~ 06.11.

HV100 Series High Performance Current Vector Inverter

04.15	Speed limit channel selection 2 of torque control mode (reverse direction)	
	0~2	0

This function code sets the reverse speed limit channel during torque control.

0: Keypad digit given 2

See 04.17 Settings for details.

1: AI1

The reverse speed limit channel for torque control is given by AI1. Please refer to the description of function code 06.00 ~ 06.05.

2: AI2

The reverse speed limit channel for torque control is given by AI2. Please refer to the description of function code 06.06 ~ 06.11.

04.16	Keyboard numbers limit speed 1	
	0.0 ~ 100.0% * [00.12] maximum frequency	100.0%

Keyboard numerals limit speed 1 to a limit relative to the maximum output frequency. This function code corresponds to the limit value of forward speed when 04.14=0.

04.17	Keyboard digital limit speed 2	
	0.0 ~ 100.0% * [00.12] maximum frequency	100.0%

Keyboard digital limit speed 2 to a limit relative to the maximum output frequency. This function code corresponds to the limit value of reverse speed when 04.15=0.

04.18	Torque rise time	
	0.0S ~ 10.0S	0.1

04.19	Torque fall time	
	0.0S ~ 10.0S	0.1

Torque rise/fall time defines the time when the torque rises from 0 to the maximum value or falls from the maximum value to 0.

04.20	Electric torque limitation in vector mode	
	G type: 0.0% ~ 200.0% * motor rated current 180.0% P type: 0.0% ~ 200.0% * rated current of motor 120.0%	Model setting
04.21	Brake torque limitation in vector mode	
	G type: 0.0% ~ 200.0% * rated current of motor 180.0% P type: 0.0% ~ 200.0% * rated current of motor 120.0%	Model setting

The above function code defines the magnitude of torque limit value when vector control is performed

04.22	Torque detection action selection	
	0~8	0
04.23	Torque detection level	
	G type: 0.0% ~ 200.0% * rated current of motor 150.0% P type: 0.0% ~ 200.0% * rated current of motor 110.0%	Model setting
04.24	Torque detection time	
	0.0~10.0S	0.0

When the actual torque is within 04.24 (torque detection time) and continuously exceeds 04.23 (torque check level), the inverter will make corresponding actions according to the setting of 04.22. When the set value of torque detection level is 100%, it corresponds to the rated torque of the motor.

0: Detection invalid

Torque detection is not performed.

1: Continue to run after detecting torque at constant speed

Over-torque is detected only in the constant speed operation process, and after the torque is detected, the inverter continues to run.

2: Continue to run after detecting torque during operation

After the torque is detected in the whole operation process, the inverter continues to run.

3: Cut off the output after the torque is detected at constant speed

Over-torque is detected only in the constant speed operation process, and after the torque is detected, the inverter stops output, and the motor slides to stop freely.

4: Cut off the output after detecting torque in operation

After the torque is detected in the whole running process, the inverter stops outputting and the motor slides and stops freely.

HV100 Series High Performance Current Vector Inverter

5: Continue running after insufficient torque is detected at constant speed

Insufficient torque is detected only in the constant speed operation process, and after the detection of insufficient torque, the inverter continues to run.

6: Continue to run after insufficient torque is detected during operation

Insufficient torque is detected in the whole operation process, and the inverter continues to run.

7: Cut off the output after detecting insufficient torque at constant speed

Only in the process of constant speed operation, whether the torque is insufficient is detected, and after the insufficient torque is detected, the inverter stops outputting, and the motor slides and stops freely.

8: Cut off the output after detecting insufficient torque during operation

After insufficient torque is detected in the whole running process, the inverter stops outputting and the motor slides and stops freely.

04.25	Cutoff frequency of static friction coefficient	
	0.00~300.00Hz	10.00
04.26	Setting of static friction coefficient	
	0.0~200.0	0.0
04.27	Static friction coefficient maintenance time	
	0.00~600.00s	0.0

As the starting torque of the motor is not enough, increasing the set value of 04.26 can increase the starting torque. When the speed exceeds the set value of 04.25, the increased torque will slowly decrease to the given torque within the set time of 04.27.

005 group -VF control parameters

完成情况

05.00	V/F curve setting	
	0~5	0

This set of function codes defines the V/F curve setting mode of the motor to meet different load characteristic requirements. According to the definition of 05.00, you can choose five fixed curves and one custom curve.

0: linear curve

The linear curve is suitable for ordinary constant torque load, and the output voltage has a linear relationship with the output frequency. See straight line 0 in figure F5-1.

1: torque reduction curve 1(1.3 power)

Torque reduction curve 1, the output voltage and output frequency are 1.3 power. See curve 1 in figure F5-1.

2: torque reduction curve 2(1.5 power)

Torque reduction curve 2, the output voltage and output frequency are 1.5 power. See curve 2 in figure F5-1.

3: torque reduction curve 3(1.7 power)

Torque reduction curve 3, the output voltage and output frequency are 1.7 power. See curve 3 in figure F5-1.

4: Square curve

The square curve is suitable for square torque loads such as fans and pumps to achieve the best energy-saving effect, and the output voltage has a square curve relationship with the output frequency. See curve 4 in figure F5-1.

5: V/F curve set by user (determined from 05.01 to 05.06)

When 05.00 is selected as 5, the user can customize the V/F curve from 05.03 to 05.08, and define the V/F curve by adding (V1, O1), (V2, F2), (V3, F3) and the polyline of origin and maximum frequency point, which is suitable for special load characteristics. As shown in figure F5 -1.

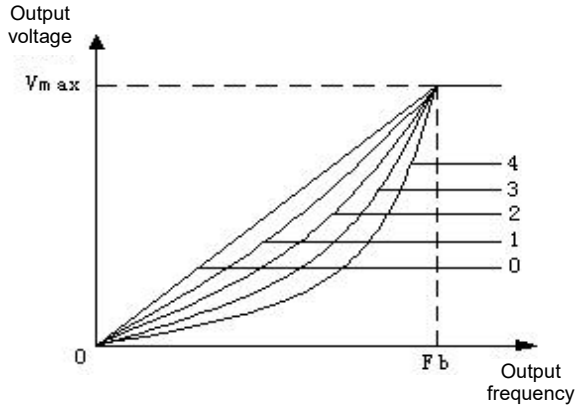

V_{max} : Maximum output voltage
 F_b : Maximum output frequency

Fig. F5-1 V/F curve diagram

05.01	Torque boost setting	
	0.0 ~ 30.0% rated Voltage of motor	Model setting
05.02	Torque boost cutoff frequency	
	0.0 ~ Motor rated Power	15.00

In order to compensate for the low-frequency torque characteristics, some boost compensation can be made for the output voltage. When this function code is set to 0.0%, it is automatic torque lifting, and when any value is not 0.0%, it is manual torque lifting mode. 05.02 defines the lifting cut-off frequency point f_z when manual torque lifting is performed, as shown in Figure F5-2.

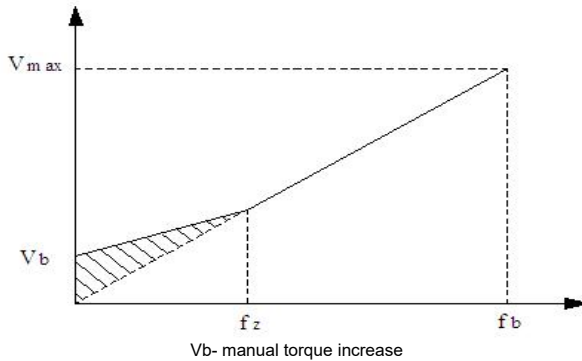

Figure F5-2 Schematic diagram of torque boost

⚠ Notes:

- 1: Under normal V/F control mode, automatic torque boost mode is invalid.
- 2: Automatic torque boost is only valid in advanced V/F control mode.

05.03	V/F frequency value F1	
	0.00 ~ Frequency value F2	12.50
05.04	V/F Voltage V1	
	0.0 ~ voltage value V2	25.0%

HV100 Series High Performance Current Vector Inverter

05.05	V/F frequency value F2	25.00
	Frequency value 01 ~ frequency value F3	
05.06	V/F Voltage value V2	50.0%
	Voltage value v1 ~ voltage value V3	
05.07	V/F frequency value F3	37.50
	Frequency value F2 ~ rated frequency of motor	
05.08	V/F Voltage value V3	75.0%
	Voltage value v2 ~ 100.0% * rated voltage of motor	

Schematic diagram of voltage and frequency is as follows:

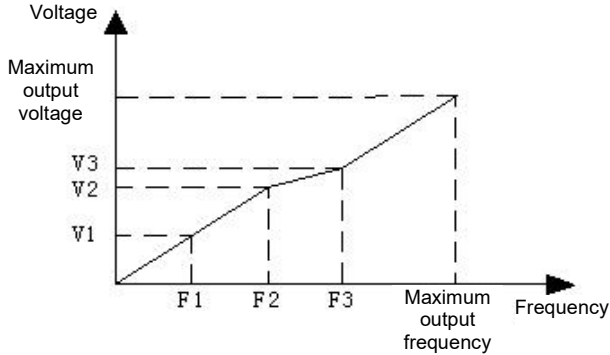

Figure F5-3 Schematic diagram of V/F curve set by users

05.09	V/F control slip frequency compensation	0.0%
	0.0 ~ 200.0% * rated slip	

The speed of asynchronous motor will decrease after being loaded. Slip compensation can make the speed of motor close to its synchronous speed, thus making the speed control accuracy of motor higher.

05.10	V/F control slip frequency filter coefficient	3
	1~10	

This parameter is used to adjust the response speed of slip frequency compensation. The larger the setting of this value, the slower the response speed and the more stable the motor speed.

05.11	V/F control torque frequency compensation filter coefficient	Model setting
	0~10	

When the free torque increases, this parameter is used to adjust the response speed of torque compensation. The larger this value is, the slower the response speed and the more stable the motor speed.

05.12	Selection of separate V/F control	0
	0~3	

0: V/F semi-separated mode, voltage open loop output

In this control mode, the inverter starts according to the normal V/F curve, and then adjusts the voltage to the set target voltage value after reaching the set frequency point. In this mode, the voltage has no feedback, and the target voltage value is set as an open loop. As shown in the figure.

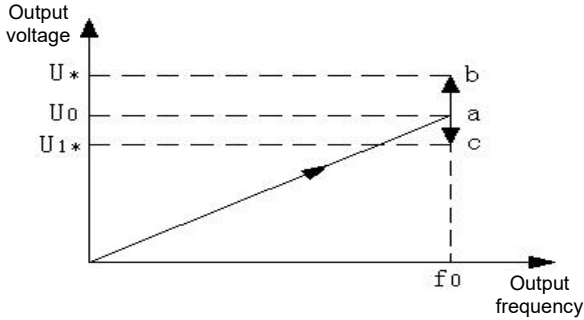

Figure F5-4 Voltage Control Mode 0

F0— set frequency, V0— rated voltage corresponding to set frequency, U*/U1* — set value of a given channel in 05.13.

As shown in the above figure, after the frequency of point A is stabilized, the voltage adjustment begins. According to the target voltage value and the input voltage, the voltage point may move to point b (increase) or point c (decrease) until it reaches to the target value.

1: VF semi-separated mode, voltage closed loop output

The only difference between this mode and mode 0 is that it introduces a voltage closed loop, which can stabilize the voltage by PI adjustment for the deviation between the feedback voltage and the given voltage. It can compensate the target voltage deviation caused by load change, and make the voltage control precision higher and the response faster, as shown in the following figure

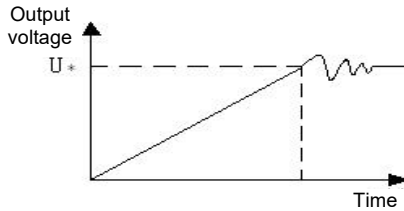
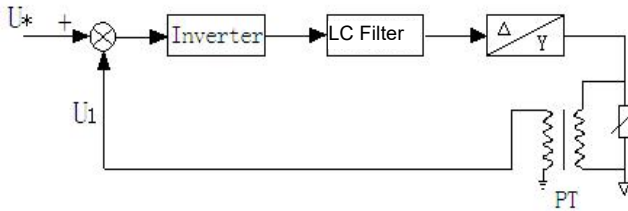

Figure F5-5 Voltage Control Mode 1

This control method is widely used in EPS power supply and other fields, and its control principle block diagram is as follows:



U*— set value of a given channel in 05.13
 U1— analog feedback voltage value (PT)
 PT— Electric quantity transmitter

Figure F5-6 EPS control principle

Tips:

The corresponding relationship between analog feedback channel voltage and actual voltage from 06.06 to 06.11 is uniquely determined by the voltage transmitter (PT), and its calculation method is as follows:

Assume that $U^* = 120\% \cdot U_e = 456 \text{ V}$ (AI1 setting)

PT transformation ratio =50 (input AC 0-500V, output DC 0-10V)

Then when the output reaches to the target voltage of 456V, the feedback voltage of PT output is

$$456/50V=9.12V$$

When the upper limit input of AI1 is 10V, the determined input voltage is 500V, and the ratio relative to the rated voltage is

$$500/380=132\%$$

Therefore, 06.09(AI2 input upper limit voltage) is set to 10.00V, and 06.10(AI2 upper limit corresponding setting) is set to 132%.

HV100 Series High Performance Current Vector Inverter

2: VF fully separated mode, voltage open-loop output

In this mode, the output frequency and voltage of the inverter are completely independent, and the frequency is accelerate and decelerate according to the defined acceleration and deceleration time, while the voltage is adjusted to the target value according to the rising/falling time defined by 05.19 and 05.20. As shown in the figure, this control mode is mainly applied to the design of some variable frequency's power supplies.

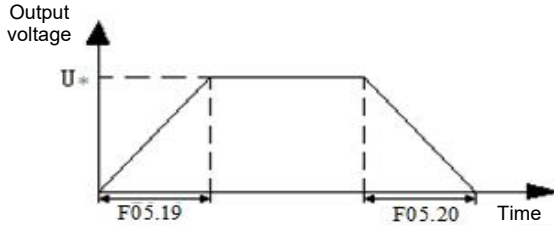

Figure F5-7 Voltage Control Mode 2

3: VF fully separated mode, voltage closed-loop output

The only difference between this mode and mode 2 is that it introduces a voltage closed loop, which can stabilize the voltage by PI adjustment for the deviation between the feedback voltage and the given voltage. It can compensate the target voltage deviation caused by load change, and make the voltage control precision higher and the response faster, as shown in the following figure

05.13	Voltage given channel	
	0~2	0

0: Digital given

Set the target voltage value by function code 05.15.

1: AI1

The target voltage value is given by the analog AI1. Pay attention to the physical quantity corresponding to AI1, and 06.00 should be set to 2 (voltage command).

2: AI2

The target voltage value is given by the analog AI2. Pay attention to the physical quantity corresponding to AI2, and 06.00 should be set to 2 (voltage command).

05.14	Voltage feedback channel of voltage closed-loop output	
	0~1	0

0: AI1

The target voltage value is given by the analog AI1. Pay attention to the physical quantity corresponding to AI1, and 06.00 should be set to 2 (voltage command).

1: AI2

The target voltage value is given by the analog AI2. Pay attention to the physical quantity corresponding to AI2, and 06.00 should be set to 2 (voltage command).

05.15	Digitally set the output voltage value	
	0.0 ~ 200.0% * rated voltage of motor	100%
05.16	Deviation limit of motor closed-loop adjustment	
	0.0 ~ 5.0% * rated voltage of motor	2.0%

Used in limited closed loop mode, allow voltage regulate to maximum deviation amplitude, so as to limit the voltage within a safe range and ensure the reliable running of equipment.

05.17	Maximum voltage of VF curve in semi-separated mode	
	0.0 ~ 100.0% * rated voltage of motor	80.0%

This function defines the maximum voltage point when starting the equipment according to the voltage and frequency curve. Reasonable setting of this function can validly prevent the voltage overshoot during starting and ensure the reliable running of the equipment.

05.18	Controller adjustment period of voltage closed-loop output	
	0.01 ~ 10.00s	0.10

This function code represents the speed of voltage adjustment. If the voltage response is slow, this parameter value can be appropriately reduced.

05.19	Voltage rising time	
	0.1 ~ 3600.0S	10.0
05.20	Voltage drop time	
	0.1 ~ 3600.0S	10.0

HV100 Series High Performance Current Vector Inverter

This function code defines the time of voltage rise and fall in the control mode where V and F are completely separated, that is, mode 2.

05.21	Voltage feedback disconnection processing	
	0~2	0

0: Alarm and maintain operation with the voltage at the time of disconnection

1: Alarm and reduce the voltage to limiting voltage for operation

2: Protect action and free stop

05.22	Voltage feedback disconnection detection value	
	0.0 ~ 100.0% * rated voltage of motor	2.0%

The maximum value of the given voltage is taken as the upper limit value of the feedback disconnection detection value. In the feedback disconnection detection time, when the voltage feedback value is continuously less than the feedback disconnection detection value, the inverter will make corresponding protection actions according to the setting of 05.21.

05.23	Voltage feedback disconnection detection time	
	0.0~100.0s	10.0

Duration before protection action after voltage feedback disconnection.

05.24	Limiting voltage of voltage feedback disconnection	
	0.0 ~ 100.0% * rated voltage of motor	80.0%

This function code defines the maximum amplitude of the output voltage of the inverter, which means that even if the protection fails, the final output voltage can also be limited within the allowable safety range when the output feedback is disconnected and the voltage is continuously raised out of control, thus greatly ensuring the safety of subsequent load work.

05.25	DC Bus undervoltage test value	
	0~1000V	0

If the parameter value set 0, the function is invalid. If the DC bus voltage is lower than the parameter value, the system will report "E-34".

05.26	Reset value of DC Bus undervoltage fault	
	0~1000V	0

If DC bus voltage is the equals of the parameter value,the system will reset the fault "E-34"and run automatically.

006 group - analog and pulse input and output parameters

06.00	AI1 input corresponding physical quantity	
	0~2	0

0: Speed command (output frequency,-100.0% ~ 100.0%)

1: Torque command (output torque,-200.0% ~ 200.0%)

AI1 analog setting regards as a given value of torque command, and the given torque range can be -200.0% ~ 200.0%. Please refer to F6 group's detailed function description for related settings.

2: Voltage command (output voltage, 0.0% ~ 200.0% * rated voltage of motor)

06.01	AI1 input lower limit	
	0.00V/0.00mA~10.00V/20.00mA	0.00
06.02	AI1 lower limit corresponds to physical quantity setting	
	-200.0% ~ 200.0%	0.0%
06.03	AI1 input upper limit	
	0.00V/0.00mA~10.00V/20.00mA	10.00
06.04	AI1 upper limit corresponds to physical quantity setting	
	-200.0% ~ 200.0%	100.0%
06.05	AI1 input filter time	
	0.00S~10.00S	0.05

HV100 Series High Performance Current Vector Inverter

06.06	AI2 input corresponding physical quantity	
	0~2	0

0: Speed command (output frequency, -100.0% ~ 100.0%)

1: Torque command (output torque, -200.0% ~ 200.0%)

AI2 analog setting regards as a given value of torque command, and the given torque range can be -200.0% ~ 200.0%. Please refer to F6 group's detailed function description for related settings.

2: Voltage command (output voltage, 0.0% ~ 200.0% * rated voltage of motor)

06.07	AI2 input lower limit	
	0.00V~10.00V	0.00
06.08	AI2 lower limit corresponds to physical quantity setting	
	-200.0% ~ 200.0%	0.0%
06.09	AI2 input upper limit	
	0.00V~10.00V	10.00
06.10	AI2 upper limit corresponds to physical quantity setting	
	-200.0% ~ 200.0%	100.0%
06.11	AI2 input filter time	
	0.00S~10.00S	0.05

The above function codes define the input ranges of analog input voltage channels AI1 and AI2 and their corresponding physical quantity percentages and filtering time constants. Among them, AI2 can be selected as voltage/current input through J1 jumper, and its digital setting can be set according to the relationship between 0 ~ 20mA and 0 ~ 10v. The specific setting should be based on the actual situation of the input signal.

The input filtering time constants of AI1 and AI2 are mainly used for filtering processing of analog input signals to eliminate the influence of interference. The larger the time constant, the stronger the anti-interference ability, the more stable the control, but the slower the response; On the contrary, the smaller the time constant, the faster the response, but the weaker the anti-interference ability, and the control may be unstable. If the optimal value cannot be determined in practical application, the value of this parameter should be appropriately adjusted according to whether the control is stable or not and the situation of response delay.

06.12	Analog input anti-shake deviation limit	
	0.00V~10.00V	0.10

When the analog input signal fluctuates frequently near a given value, the frequency fluctuation caused by this fluctuation can be suppressed by setting 06.12.

06.13	Zero frequency operation threshold	
	Zero frequency return difference ~ 50.00Hz	0.00

When 00.15=1 (high frequency mode), the maximum value of this function code is 500.0Hz.

06.14	Zero frequency return difference	
	0.00 ~ zero frequency operation threshold	0.00

These two function codes are used to set the zero frequency return control function. Take the analog AI1 current given channel as an example, as shown in Figure F6-1.

Starting process:

After the running command is issued, only when the analog AI1 current input reaches or exceeds a certain value I_b and its corresponding stated frequency reaches f_b , the motor starts to start and accelerates to the frequency corresponding to the simulated AI1 current input according to the acceleration time.

Shutdown process:

In the process of running, when the current value of AI1 is reduced to I_b , the inverter will not stop immediately, and only when the current of AI1 continues to decrease to I_a and the corresponding stated frequency is f_a , will the inverter stop outputting. Here, f_b is defined as zero frequency operation threshold, which is defined by 06.13, and the value of f_b-f_a is defined as zero frequency return difference, which is defined by function code 06.14.

With this function, the sleep function can be completed, the energy-saving running can be realized, and the inverter can be prevented from starting frequently at the threshold frequency through the width of the return difference.

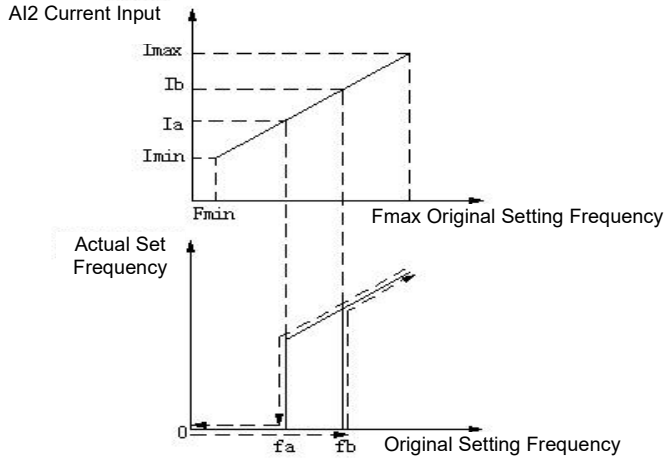

fb :Zero frequency operation threshold
 fa : fb – zero frequency return difference

Figure F6-1 Schematic diagram of zero frequency function

06.15	External pulse input corresponds to physical quantity	
	0~1	0

0: Speed command (output frequency,-100.0% ~ 100.0%)

1: Torque command (output torque,-200.0% ~ 200.0%)

06.16	Lower limit of external pulse input	
	0.00 ~ 50.00kHz	0.00
06.17	The lower limit of external pulse corresponds to the setting of physical quantity	
	-200.0% ~ 200.0%	0.0%
06.18	upper limit of external pulse input	
	0.00 ~ 50.00kHz	50.00
06.19	The upper limit of external pulse corresponds to the setting of physical quantity	
	-200.0% ~ 200.0%	100.0%
06.20	External pulse input filtering time	
	0.00S ~ 10.00S	0.05

The above function code defines the input range of the pulse input channel and the corresponding physical quantity percentage. At this time, the multi-function terminal DI6 must be defined as the 'pulse frequency input' function.

The pulse input filtering time constant is mainly used for filtering process of the pulse signal. The principle is the same as the analog input filtering time constant.

06.21	Function Selection of AO1 multifunctional Analog Output Terminal	
	0 -14	0
06.22	Function Selection of AO2 multifunctional Analog Output Terminal	
	0-14	4
06.23	Function selection of HDO multifunctional pulse output terminal	
	0 -14	11

The above function codes determine the corresponding relationship between multifunctional analog output terminal AO and pulse output terminal HDO and various physical quantities, as shown in the following table:

HV100 Series High Performance Current Vector Inverter

Item	AO	Scope of project
Output frequency (before slip compensation)	Upper limit of 0V/0mA ~ AO	0 ~ Max output frequency
	Upper limit of 2V/4mA ~ AO	0 ~ Max output frequency
Output frequency (after slip compensation)	Upper limit of 0V/0mA ~ AO	0 ~ Max output frequency
	Upper limit of 2V/4mA ~ AO	0 ~ Max output frequency
Set frequency	Upper limit of 0V/0mA ~ AO	0 ~ Max output frequency
	Upper limit of 2V/4mA ~ AO	0 ~ Max output frequency
Revolving speed of motor	Upper limit of 0V/0mA ~ AO	0 ~ synchronous speed of motor
	Upper limit of 2V/4mA ~ AO	0 ~ synchronous speed of motor
Output current	Upper limit of 0V/0mA ~ AO	0 ~ 2 times rated current
	Upper limit of 2V/4mA ~ AO	0 ~ 2 times rated current
Output voltage	Upper limit of 0V/0mA ~ AO	0 ~ 1.2 times rated Output voltage
	Upper limit of 2V/4mA ~ AO	0 ~ 1.2 times rated Output voltage
Bus voltage	Upper limit of 0V/0mA ~ AO	0 ~ 800V
	Upper limit of 2V/4mA ~ AO	0 ~ 800V
PID given quantity	Upper limit of 0V/0mA ~ AO	0V/0mA ~ 10V/20mA
	Upper limit of 2V/4mA ~ AO	0V/0mA ~ 10V/20mA
PID feedback quantity	Upper limit of 0V/0mA ~ AO	0V/0mA ~ 10V/20mA
	Upper limit of 2V/4mA ~ AO	0V/0mA ~ 10V/20mA
AI1	Upper limit of 0V/0mA ~ AO	0V/0mA ~ 10V/20mA
	Upper limit of 2V/4mA ~ AO	0V/0mA ~ 10V/20mA
AI2	Upper limit of 0V/0mA ~ AO	0V/0mA ~ 10V/20mA
	Upper limit of 2V/4mA ~ AO	0V/0mA ~ 10V/20mA
Frequency of Input pulse	Upper limit of 0V/0mA ~ AO	0 ~ 50KHZ
	Upper limit of 2V/4mA ~ AO	0 ~ 50KHZ
Torque current	Upper limit of 0V/0mA ~ AO	0 ~ 2 times rated current
	Upper limit of 2V/4mA ~ AO	0 ~ 2 times rated current
Magnetic flux current	Upper limit of 0V/0mA ~ AO	0 ~ 2 times rated current
	Upper limit of 2V/4mA ~ AO	0 ~ 2 times rated current
communication settings	Upper limit of 0V/0mA ~ AO	0% ~ 100% * AO upper limit value
	Upper limit of 2V/4mA ~ AO	0% ~ 100% * AO upper limit value

The range of HDO is from the lower limit of HDO ~ HDO upper limit, which corresponds to the lower limit and upper limit of each physical quantity in the above table.

06.24	AO1 output lower limit corresponds to physical quantity	0.0%
	-200.0% ~ 200.0%	
06.25	AO1 output lower limit	0.00
	0.00 ~ 10.00V	
06.26	AO1 output upper limit corresponds to physical quantity	100.0%
	-200.0% ~ 200.0%	
06.27	AO1 output upper limit	10.00
	0.00 ~ 10.00V	
06.28	AO2 output lower limit corresponds to physical quantity	0.0%
	-200.0% ~ 200.0%	

HV100 Series High Performance Current Vector Inverter

06.29	AO2 output lower limit	
	0.00~10.00V	0.00
06.30	AO2 output upper limit corresponds to physical quantity	
	-200.0% ~ 200.0%	100.0%
06.31	AO2 output upper limit	
	0.00~10.00V	10.00
06.32	DO output lower limit corresponding to physical quantity (reservation)	
	-200.0% ~ 200.0%	0.0%
06.33	Lower limit of DO output (reservation)	
	0.00~50.00kHz	0.00
06.34	DO output upper limit corresponding to physical quantity (reservation)	
	-200.0% ~ 200.0%	100.0%
06.35	DO output upper limit (reservation)	
	0.00~50.00kHz	50.00
06.36	AI multi-point curve selection	
	0000~011	0000

LED bit: AI1 multi point curve selection

0: Forbidden

1: Effective

LED10-dight: AI2 Multi point curve selection

0: Forbidden

1: Effective

LED100-dight: analog input signal selection

0: AI1 and AI2 input signals are 0 ~ 10V

1: AI1 input signal is 4 ~ 20mA, and AI2 input signal is 0 ~ 10V

2: AI2 input signal 4 ~ 20mA, AI1 input signal 0 ~ 10V

3: AI1 and AI2 input signals are 4 ~ 20mA

LED1000-dight: Reserved

06.37	AI1 curve minimum input	
	0.00~ 【06.39】	0.00
06.38	AI1 curve minimum input corresponding setting	
	-200.0% ~ 200.0% Note: the range is associated with 06.00	0.0%
06.39	AI1 curve inflection point 1 input	
	【06.37】 ~ 【06.41】	3.00
06.40	AI1 curve inflection point 1 input corresponding setting	
	-200.0% ~ 200.0% Note: the range is associated with 06.00	30.0%
06.41	AI1 curve inflection point 2 input	
	【06.39】 ~ 【06.43】	6.00
06.42	AI1 curve inflection point 2 input corresponding setting	
	-200.0% ~ 200.0% Note: the range is associated with 06.00	60.0%
06.43	Maximum input of AI1 curve	
	【06.41】 ~10.00	10.00
06.44	AI1 curve maximum input corresponding setting	
	-200.0% ~ 200.0% Note: the range is associated with 06.00	100.0%
06.45	AI2 curve minimum input	
	0.00~ 【06.39】	0.00
06.46	AI2 curve minimum input corresponding setting	
	-200.0% ~ 200.0% Note: the range is associated with 06.06	0.0%

HV100 Series High Performance Current Vector Inverter

06.47	AI2 curve inflection point 1 input	
	【06.37】 ~ 【06.41】	3.00
06.48	AI2 curve inflection point 1 input corresponding setting	
	-200.0% ~ 200.0% Note: the range is associated with 06.06	30.0%
06.49	AI2 curve inflection point 2 input	
	【06.39】 ~ 【06.43】	6.00
06.50	AI2 curve inflection point 2 input corresponding setting	
	-200.0% ~ 200.0% Note: the range is associated with 06.06	60.0%
06.51	AI2 curve maximum input	
	【06.41】 ~ 10.00	10.00
06.52	AI2 curve maximum input corresponding setting	
	-200.0% ~ 200.0% Note: the range is associated with 06.06	100.0%

The multi-point curves of AI1 and AI2 are selected by 06.36, and the corresponding relation of specific settings is shown in Figure F6-2.

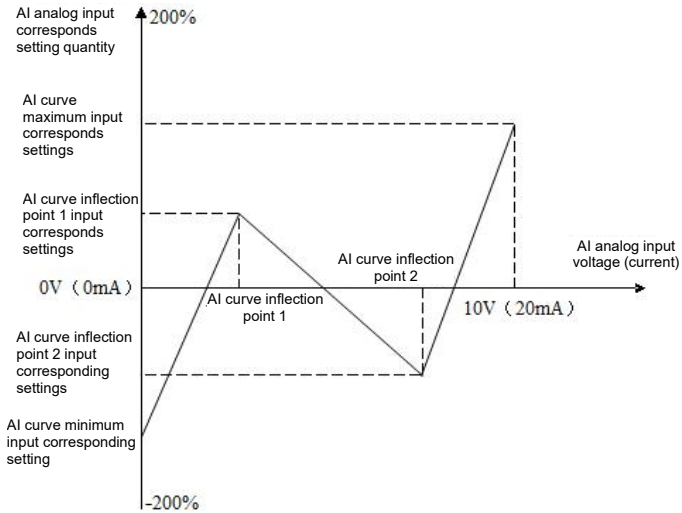

Fig. F6-2 Schematic diagram of multi-point curve

06.53	AI1 input voltage protection upper limit	
	【06.54】 ~ 10.00V	6.80
06.54	AI1 input voltage protection lower limit	
	0.00V ~ 【06.53】	3.10

For details, please refer to the function description of No.57 (AI1 input overrun) in the function code 07.18 ~ 07.21.

007 group-digital input and output parameters

07.00	Input terminal DI1 function (when 00.01 is 2 or 3, the default function is 58)	
	0~65	1
07.01	Input terminal DI2 function (when 08.21 is not 0 value, the default function is 59)	
	0~65	2

HV100 Series High Performance Current Vector Inverter

07.02	Input terminal DI31 function (when 00.01 is 2 or 3, the default function is 60)	
	0~65	4
07.03	Input terminal DI4 function (when 00.01 is 2 or 3, the default function is 61)	
	0~65	7
07.04	Input terminal DI5 function (when 00.01 is 2 or 3, the default function is 62)	
	0~65	8
07.05	Input terminal DI6 function (when 00.01 is 2 or 3, the default function is 63)	
	0~65	0
07.06	HDI function of input terminal (high speed pulse input)	
	0~65	45
07.07	Reservation	
	—	0

0: None

1: Forward rotation control (FWD)

Terminal and COM short circuit, the inverter is running forward, only valid when 00.06=1.

2: Reverse rotation control (REV)

Terminal and COM short circuit, inverter is running reversely, only valid when 00.06=1.

3: Three-wire control

Refer to the functional description of operation modes 2 and 3 (three-wire control modes 1 and 2) in 07.11.

4: Forward jog control

Terminal and COM short circuit, the inverter is forward jogging running, only valid when 00.06=1.

5: Reverse jog control

Terminal and COM short circuit, inverter reverse jogging running, only valid when 00.06=1.

6: Free stop control

This function has the same meaning as the free running shutdown defined in 01.08, but it is realized by control terminals here, which is convenient for remote control.

7: External reset signal input (RST)

When the inverter fails, the fault can be reset through this terminal. Its function is consistent with the function of (STOP/RESET) key. This function is valid under any command channel.

8: External equipment fault normally open (NO) input

9: External equipment fault normally close (NC) input

The fault signal of external equipment can be input through this terminal, which is convenient for the inverter to monitor the fault of external equipment. After receiving the external equipment fault signal, the inverter displays E-19, that is, the external equipment fault alarm. The fault signal can be input in two ways: normally open and normally closed.

10: Emergency stop function (brake at the fastest speed)

This function is used for emergency stop. The terminal is short-circuited with COM, and the emergency standby deceleration time (01.36) is used to decelerate and brake.

11: Reservation

12: Frequency increment command

Terminals are short-circuited with COM, and the frequency increase, which is only valid when the frequency given channel is digital given 2 (terminal UP/DOWN adjustment).

13: Frequency decrement command

Terminals are short-circuited with COM, and the frequency decreases, which is only valid when the frequency given channel is digital given 2 (terminal UP/DOWN adjustment).

14: UP/DOWN terminal frequency is cleared

Clear the increment of digital frequency 2 (frequency adjusted by UP/DOWN terminal) through the terminal.

15: Multi-speed selection 1

16: Multi-speed selection 2

17: Multi-speed selection 3

18: Multi-speed selection 4

Up to 16 speeds can be selected by selecting the ON/OFF combination of these function terminals. As shown in the table below:

HV100 Series High Performance Current Vector Inverter

Multi-speed selection SS4	Multi speed Selection SS3	Multi speed Selection SS2	Multi speed Selection SS1	Segment speed
OFF	OFF	OFF	OFF	0
OFF	OFF	OFF	ON	1
OFF	OFF	ON	OFF	2
OFF	OFF	ON	ON	3
OFF	ON	OFF	OFF	4
OFF	ON	OFF	ON	5
OFF	ON	ON	OFF	6
OFF	ON	ON	ON	7
ON	OFF	OFF	OFF	8
ON	OFF	OFF	ON	9
ON	OFF	ON	OFF	10
ON	OFF	ON	ON	11
ON	ON	OFF	OFF	12
ON	ON	OFF	ON	13
ON	ON	ON	OFF	14
ON	ON	ON	ON	15

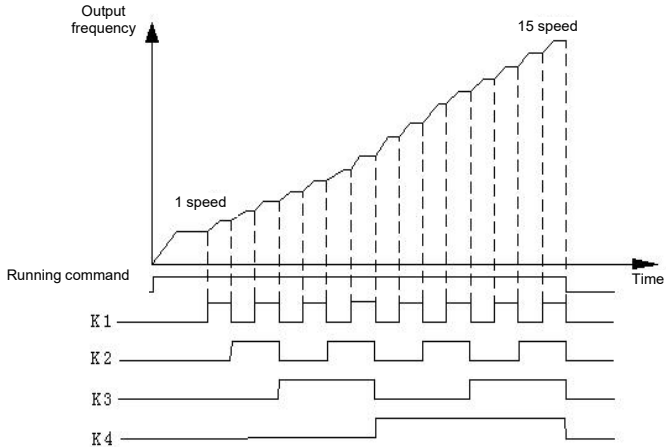

Figure F7-1 Schematic diagram of Multi speed operation

19: Acceleration or deceleration time selection TT1

20: Acceleration or deceleration time selection TT2

By selecting the ON/OFF combination of these functional terminals, you can choose up to four acceleration/deceleration times. As shown in the table below:

Select terminal 2 for acceleration and deceleration time	Select terminal 1 for acceleration and deceleration time	Acceleration or deceleration time selection
OFF	OFF	Acceleration time 1/ deceleration time 1
OFF	ON	Acceleration time 2/ deceleration time 2
ON	OFF	Acceleration time 3/ deceleration time 3
ON	ON	Acceleration time 4/ deceleration time 4

21: Running command channel selection 1

22: Running command channel selection 2

By selecting the ON/OFF combination of these functional terminals, you can choose up to three running command channels and four ways. As shown in the table below:

HV100 Series High Performance Current Vector Inverter

Running command channel selection terminal 2	Running command channel selection terminal 1	Running command channel
OFF	OFF	Determined by function code 00.06
OFF	ON	0: the operation panel runs the command channel
ON	OFF	1: terminal running command channel
ON	ON	2: communication running command channel

23: Inverter Forbidden acceleration/deceleration command

When the terminal is valid, the inverter will not be affected by external signals (except shutdown command), and maintain the current frequency running.

24: Inverter run forbidden command

When the terminal is valid, the inverter in operation is free to shut down, while starting is prohibited in standby state. Mainly used for occasions requiring safety linkage

25: Switch to keypad run command

When the terminal is valid, the running command is forcibly converted from the current channel to the panel control, the terminal is disconnected, and return to the previous running command channel.

26: Switch to terminal run command

When the terminal is valid, the running command is forcibly converted from the current channel to the terminal control, the terminal is disconnected, and return to the previous running command channel.

27: Switch to communicate run command

When the terminal is valid, the running command is forcibly converted from the current channel to communication control, the terminal is disconnected, and return to the previous running command channel.

28: Auxiliary frequency is cleared

Only valid for digital auxiliary frequency (00.08 = 0, 1, 2). When this function terminal is valid, the auxiliary frequency will be cleared quantitatively, and the set frequency will be completely determined by the main given frequency.

29: Frequency source A switch to $K * B$

This terminal is valid. If 00.09 (frequency combination algorithm) selects 6, the given frequency channel will be forcibly switched to frequency source B, and the given frequency channel will be restored to A after being invalid.

30: Frequency source A switch to $A + K * B$

This terminal is valid. If 00.09 (frequency combination algorithm) selects 7, the given frequency channel will be forcibly switched to frequency source ($A + k * B$), and the given frequency channel will be restored to A after being invalid.

31: Frequency source A switch to $A - K * B$

This terminal is valid. If 00.09 (frequency combination algorithm) selects 8, the given frequency channel will be forcibly switched to frequency source ($A - k * B$), and the given frequency channel will be restored to A after being invalid.

32: Reservation

33: PID control input

When the frequency given channel is PID given, and the PID input mode is manual input, the terminal is valid, and PID running is entered. Please refer to F8 group parameter setting for detailed function codes.

34: PID control pause

Used to realize pause control of PID in running. When the terminal is valid, PID adjustment stops, and the frequency of inverter stops running at the current frequency. After the terminal is invalid, PID adjustment will continue, and the operating frequency will change with the change of adjustment amount.

35: Swing frequency control input

When the swing frequency starting mode is manual input, the swing frequency function is valid when the terminal is valid. If it is invalid, it will run at the preset frequency of swing frequency. Please refer to the description of function code 09.55 ~ 09.65.

36: Swing frequency control pause

Terminal and COM short circuit, inverter pause the operation mode of swing frequency, and the frequency of inverter stops running at the current frequency; After the terminal is invalid, continue to swing frequency running.

37: Swing frequency state reset

When this function is selected, whether in automatic or manual input mode, closing this terminal will clear the frequency swing state information memorized in the inverter. After disconnecting this terminal, the swing frequency starts again (if there is a preset frequency, run the preset frequency first). Please refer to the description of function code 09.55 ~ 09.65.

38: PLC control input

When the PLC input mode is manually input through the defined multi-function terminal, the terminal is valid, and when the operation command arrives, the PLC runs normally; If the terminal is invalid, when the running command arrives, it will run at zero frequency.

39: PLC pause

It is used to realize pause control of the running PLC process. If the terminal is valid, the inverter runs at zero frequency, and the PLC does not time; After the terminal is invalid, the inverter starts in the way of speed tracking, and continues the PLC running. Please refer to the description of function code 09.00 ~ 09.53.

HV100 Series High Performance Current Vector Inverter

40: PLC reset

In the shutdown state of PLC operation mode, when this function terminal is valid, the information such as PLC operation stage, operation time and operation frequency memorized by PLC shutdown will be cleared; After the function terminal is invalid, the operation will be restarted. See F9 group function code description

41: Count clearance signal

Terminals are short-circuited with COM, and the internal counter is reset, which is used in conjunction with function No.42.

42: Counter trigger signal input

When a pulse is received at the counting pulse input port of the internal counter, the counting value of the counter increases by 1 (if the counting mode is counting down, it decreases by 1), and the highest frequency of counting pulses is 200Hz. See description of function code 07.31 ~ 07.33 for details.

43 Timing trigger input

Trigger port of internal timer. See description of function code 07.35 ~ 07.36 for details.

44: Timing clearance signal

Terminals are short-circuited with COM, and the internal timer is reset, which is used in conjunction with function No.43.

45: External pulse frequency input (only valid for HDI-DI6)

The main frequency channel A selects the pulse input port with given pulse, which is only valid for DI6 and is set in accordance with 00.07.

46: Length zero clearance

When this function terminal is valid, 09.69 (actual length) data will be cleared to prepare for recalculation of length.

Refer to 09.67 ~ 09.73 functional parameters.

47: Length count input (only valid for HDI-DI6)

It is only valid for multifunctional input terminal DI6, which receives pulse signals as a given length. Refer to 09.67 ~ 09.73 group of functional parameters for the relationship between the number of input signal pulses and the length.

48: Speed and torque control switching

When the speed and torque control selection conditions are valid (terminal switching), the terminal is valid, then it is torque control; If the terminal is invalid, it is speed control. Please refer to 04.10 ~ 04.11 for the setting of related function codes, where 04.11 is the delay time of speed and torque switching.

49: Torque control is prohibited

Torque control mode of inverter is prohibited

50~55: Reservation

56~57: Reservation

58: Start/stop (manual)

When the terminal is valid, the frequency is given by AI1. PID control is not carried out, and it is controlled by interlocking signal. The interlocking signal who puts into operation first starts first, and who puts into operation together starts a small signal.

59: Operation permission (DI2)

This terminal is used to control the start and stop of inverter, which is generally controlled by external water shortage or high voltage signal.

60: Interlock 1 (DI3)

After this terminal is connected, it is output corresponding to the open collector Y1.

61: Interlock 2 (DI4)

After the terminal is connected, it is output corresponding to the open collector Y2.

62: Interlock 3(DI5)

When this terminal is connected, it is output corresponding to the relay R1.

63: PFC start/stop (DI6)

When the terminal is valid, PID control is carried out, which is controlled by interlocking signals. The interlocking signal who puts into operation first starts first, and who puts into operation together starts a small signal.

64: Frequency source A is switched to B and run

If the terminal is connected validly in the running state, the frequency is switched from A frequency source to B frequency source; If the terminal is connected validly in the shutdown state, the frequency will be switched to the B frequency source and runs.

65: The 1st group PID switch to the 2nd group PID

07.08	Times of D filtering	
	1~10	5

Used to set the sensitivity of the input terminal. If the digital input terminal is susceptible to interference and causes misoperation, this parameter can be increased to enhance the anti-interference ability, but the sensitivity of the input terminal will be reduced if the setting is too large.

07.09	Selection of terminal function detection when power on	
	0~1	0

HV100 Series High Performance Current Vector Inverter

0: the terminal operation command is invalid when power-on

In the process of power-on, even if the inverter detects that the operation command terminal is valid (closed), the inverter will not start. Only when the terminal is closed again after disconnection can the inverter start.

1: the terminal operation command is valid when power on

In the process of power-on, the inverter can start when it detects that the terminal operation command terminal is valid (closed).

07.10	Input terminal valid logic setting (DI1~HDI)	
	0~7FH	00

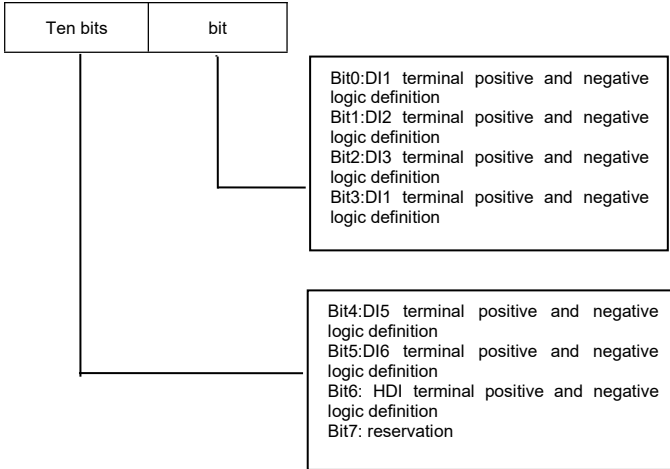

0: Positive logic, that is, the connection between Xi terminal and common terminal is valid, and the disconnection is invalid

1: Anti-logic, that is, the connection between Xi terminal and common terminal is invalid, and the disconnection is valid

07.11	FWD/REV terminal control mode	
	0~3	0

This function code defines four different ways to control the running of inverter through external terminals.

0: Two-wire control mode 1

Xm: forward command (FWD), Xn: reverse command (REV), Xm and Xn represent any two terminals respectively defined as FWD and REV functions in DI1-HDI. In this control mode, K1 and K2 can independently control the running and direction of the inverter

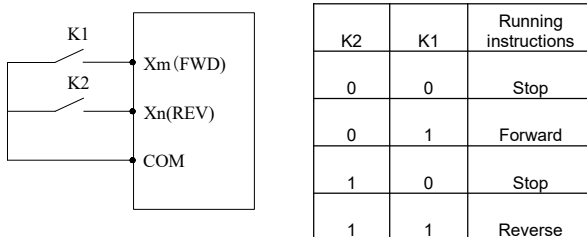

Figure F7-2 Schematic diagram of two-wire control mode 1

1: Two-wire control mode 2

Xm: forward command (FWD), Xn: Reverse command (REV), Xm and Xn represent any two terminals respectively defined as FWD and rev functions in DI1-HDI. In this control mode, K1 is the running and stopping switch, and K2 is the direction change switch.

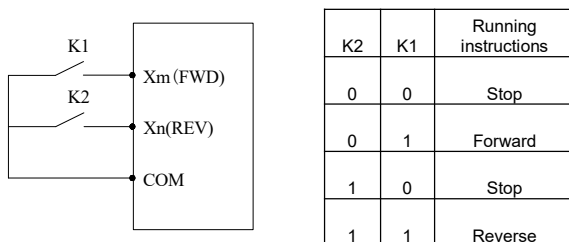

Figure F7-3 Schematic diagram of two-wire control mode 2

2: Three-wire control mode 1

Xm: forward command (FWD), Xn: reverse command (REV), Xx: shutdown command, Xm, Xn and Xx represent any three terminals respectively defined as FWD, REV and three-wire operation control functions in DI1-HDI. The connected K1 and K2 are invalid before K3 is connected. When K3 is connected, K1 is triggered, and the inverter rotates forward. When triggering K2, invert rotates reversely; When disconnecting K3, the inverter stops.

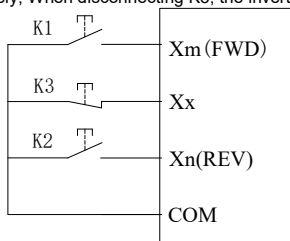

Figure F7-4 Schematic diagram of three-wire control mode 1

3: Three-wire control mode 2

Xm: running command, Xn: running direction selection, Xx: shutdown command, Xm, Xn and Xx represent any 3 terminals respectively defined as FWD, REV and three-wire operation control functions in DI1-HDI. The connected K1 and K2 are invalid before K3 is connected. When K3 is connected, K1 is triggered, and the inverter rotates forward; When triggering K2 alone, it is invalid; After K1 triggers the operation, K2 is triggered again, and the running direction of the inverter is switched. When disconnect K3, the inverter stops.

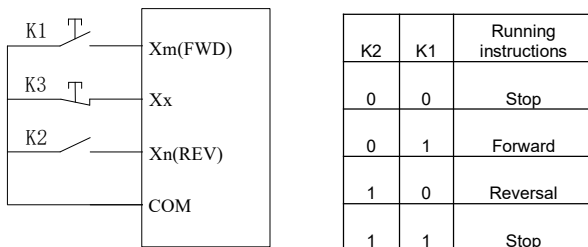

Figure F7-5 Schematic diagram of three-wire control mode 2

⚠ Notes:

When the three-wire control mode 2 is running in forward rotation, the terminal defined as REV can stably reverse when it is closed, and when it is disconnected, it will return to forward rotation.

HV100 Series High Performance Current Vector Inverter

07.12	UF/DOWN terminal frequency modification rate	
	0.01~50.00Hz/S	1.00

This function code is the frequency modification rate when setting the frequency of the UP/DOWN terminal, that is, the amount of frequency change, when the UP/DOWN terminal is short-circuited with the COM terminal for one second; When 00.18=1 (high frequency mode), the maximum value of this function code is 500.0 Hz/s.

07.13	Reservation	
	—	0

07.14	Y1 output delay time	
	0.0~100.0S	0.0
07.15	Y2 output delay time	
	0.0~100.0S	0.0
07.16	R1 output delay time	
	0.0~100.0S	0.0
07.17	R2 output delay time	
	0.0~100.0S	0.0

This function code defines the delay from the change of digital output terminal and relay state to the output change.

07.18	Open collector output terminal Y1 is set	
	0~62	0
07.19	Open collector output terminal Y2 is set	
	0~62	0
07.20	Output of programmable relay R1	
	0~62	3
07.21	Output of programmable relay R2	
	0~62	0

- 0: None
- 1: The inverter runs forward
When the inverter is in the forward running state, output indication signal.
- 2: Inverter reverse operation
When the inverter is in reverse operation state, output indication signal.
- 3: Fault output
When the inverter fails, output indication signal.
- 4: Frequency/speed level detection signal (FDT1)
Refer to 07.24 ~ 07.26 parameter function description.
- 5: Frequency/speed level detection signal (FDT2)
Refer to 07.27 ~ 07.29 parameter function description.
- 6: Frequency/Speed Arrival Signal (FAR)
Refer to 07.23 Parameter Function Description.
- 7: Indication in zero speed running of inverter
The output frequency of the inverter is 0.00Hz, but it is still in the running state.
- 8: Output frequency reaches upper limit
When the output frequency of the inverter reaches the upper limit frequency, output indication signal.
- 9: Output frequency reaches lower limit
When the output frequency of the inverter reaches the lower limit frequency, output indication signal.
- 10: The set lower limit of frequency reaches in running time
When the inverter is running, if the set frequency is less than or equal to the lower limit frequency, output an indication signal.
- 11: Inverter overload pre-alarm signal
When the output current of the inverter exceeds the overload pre-alarm level (10.12), the indicator signal is output after the alarm delay time (10.13). Commonly used for overload pre-alarm.

12: Output of counter detection signal

When the count detection value arrives, an indication signal is output, and it is not cleared until the count reset value arrives. Please refer to the description of function code 07.33.

13: Counter reset signal output

When count reset value arrives, the indicator signal is output, please refer to the description of function code 07.32.

14: Inverter operation in ready 1

When the power-on is ready, that is, the inverter is trouble-free, the bus voltage is normal, the inverter forbidden terminal is invalid, and the operation instruction can be directly accepted for starting (excluding the inverter operation), then the terminal outputs an indication signal.

15: Programmable multi-speed operation is completed in one cycle

The programmable multi-speed (PLC) outputs a valid pulse signal with a signal width of 500mS after one cycle operation.

16: The programmable multi-speed stage operation is completed

After the current operation stage of programmable multi-speed (PLC) is completed, a valid pulse signal is output with a signal width of 500mS.

17: upper limit and lower limit of swing frequency

After selecting the swing frequency function, if the frequency fluctuation range of the swing frequency, calculated by the center frequency, exceeds the upper limit frequency F00.13 and falls below the lower limit frequency 00.14, there is output an signal. As shown in the figure below:

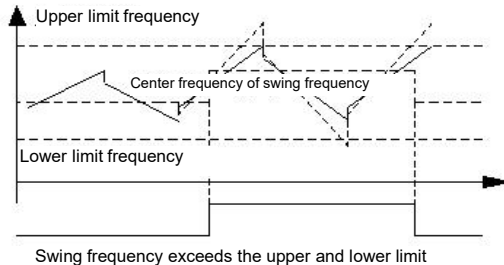

Figure F7-6 Schematic diagram of swing frequency amplitude limitation

18: Current limit in operation

It is the output signal when the inverter is in a current limit. Please refer to the description of function codes 10.06 ~ 10.08 for current limit protection settings.

19: Overvoltage stall in operation

It is the signal output when the inverter is in overvoltage stall operation. Please refer to the description of function code 10.04 for setting of overvoltage stall protection.

20: Undervoltage block and stop

When the DC bus voltage is lower than the undervoltage limit level, there is an indication signal.

Notes:

When the Bus is under-voltage during shutdown, digital tube displays "PoFF": When the bus is under-voltage during operation, if 10.02=0, the digital tube displays "PoFF"; if 10.02=1, the digital tube displays E-07 in fault, and the warning indicator lights up at the same time.

21 Sleeping State

When the inverter is in the sleep state, the inverter will output indication signal.

22: Alarm signal of inverter

If there are the cases in the inverter of PID disconnection, RS485 communication failure, panel communication failure, EEPROM reading and writing failure, encoder disconnection, etc., the inverter will output an indication signal.

23: AI1 > AI2

When the analog input AI1 > AI2, the inverter outputs the indication signal. Please refer to 06.05 ~ 06.11 parameter description for details of analog input.

24: Output when length reach

When the actual length (09.69) is greater than or equal to the set length (09.68), an indication signal is output. The length counting terminal DI6 is set to function No.47.

25: Timing time arrives

When the actual timing time is \geq 07.36 (set timing time), the inverter will output the indication signal.

26: Dynamic braking action

When the inverter dynamic braking runs, it outputs indication signal. Please refer to the function code 12.00 ~ 12.03 for the setting of dynamic braking function.

27: DC brake action

HV100 Series High Performance Current Vector Inverter

When the inverter DC braking runs, it outputs indication signal. For DC brake setting, please refer to function codes 01.00 ~ 01.12.

28: Flux braking action

When the inverter runs the flux braking, it outputs indication signal. For flux braking setting, please refer to function codes 01221.

29: Torque in limit

When the control mode is torque control, an indication signal is output. For details of torque control, please refer to group 04.10 ~ 04.23 parameter description.

30: Over-torque indication

The inverter is set according to 04.22 ~ 04.24, and outputs corresponding indication signals.

31: Auxiliary motor 1

32: Auxiliary motor 2

Terminal function of auxiliary motor 1 and 2 cooperate with process PID function module, that will realize simple constant pressure water-supply function in one drive to control three motor.

33: The accumulated running time has arrived

When the inverter running limit time (12.11) reached, it outputs indication signal.

34 ~ 49: multi-speed or simple PLC operation segment number indication

Items 34 ~ 49 of the output terminal function respectively correspond to the 0 ~ 15 segments of multi-speed or simple PLC. When the corresponding segment number, which is set by the output terminal, has arrived, then the inverter outputs an indication signal.

50: Inverter operation indication

When the inverter is in the forward or reverse running state, it outputs indication signal.

51: Temperature arrival indication

When the actual temperature (D-33 ~ D-34) is higher than the temperature detection limit (10.14), the inverter outputs an indication signal.

52: indication of Inverter shutdown or zero speed running

53~54: Reservation

55: communication settings

Please refer to the communication protocol.

56: Inverter operation in ready 2

It has the same function as the above No.14 (Inverter operation in ready 1), except that when the inverter is running, it outputs an indication signal.

57: AI1 input overrun

When the value of analog input AI1 is greater than 06.53(AI1 input voltage protection upper limit) or less than 06.54(AI1 input voltage protection lower limit), an indication signal is output.

58: output current is beyond the limit

59: Interlock 1 Output

60: Interlock 2 Output

61: Interlock 3 Output

62: Output when frequency and current detection level arrive at the same time

When the output frequency of the inverter rises higher than the set value of FDT1 level setting (07.25), and the output current reaches the set value of 10.23, it outputs an valid signal (open collector signal, which will become low level after the resistor is pulled up). While the output frequency drops below FDT1 signal (set value-hysteresis value), or the output current is less than the set value of 10.23, it outputs an invalid signal (high impedance state).

07.22	Effective logic setting of output terminal (Y1~Y2)	
	0~3H	0

Bit0: valid logic definition of Y1 terminal

Bit1: valid logic definition of Y2 terminal

0: indicates positive logic, that is valid for connection between Yi terminal and common terminal, and is invalid for disconnection.

1: means anti-logic, that is invalid for connection between Yi terminal and common terminal is invalid, and valid for disconnection.

When 07.22=0, is valid for connection between terminals Y1, Y2 and the common terminal, while invalid for disconnection.

When 07.22=1, is invalid for connection between Y1 terminal and common terminal, but the opposite is valid; while invalid for connection between Y2 terminal and common terminal, but disconnection is valid

When 07.22=2, is valid for connection between Y1 terminal and common terminal, but the opposite is invalid; while invalid for connection between Y2 terminal and common terminal, but disconnection is valid

When 07.22=3, is invalid for connection between terminals Y1, Y2 and the common terminal, while valid for disconnection.

07.23	The frequency reaches the FAR detection width	
	0.0 ~ 100.0% * [00.12] maximum frequency	100.0%

This function is a supplementary explanation to the function No.6 of function code 07.18 ~ 07.21. When the output frequency of the inverter is within the positive and negative detection width of the set frequency, the terminal outputs an valid signal (open collector signal, which is low level after the resistance is pulled up). As shown in the figure below:

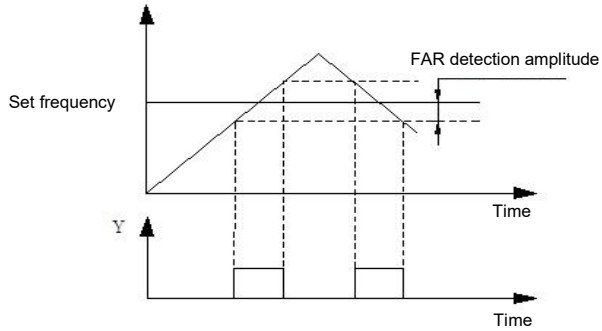

Figure F7-7 Schematic diagram of frequency arrive

07.24	FDT1 detection mode	0
	0~1	

0: speed setting value
1: speed detection value

07.25	FDT1 level setting 0.00Hz~【00.13】 upper limit frequency	50.00
07.26	FDT1 hysteresis value 0.0~100.0%*【07.25】	2.0%
07.27	FDT2 detection mode 0~1	0

0: speed setting value
1: speed detection value

07.28	FDT2 level setting 0.00Hz~【00.13】 upper limit frequency	25.00
07.29	FDT2 hysteresis value 0.0~100.0%*【07.28】	4.0%

The above function codes (07.24 ~ 07.29) are supplementary descriptions for functions No.4 and No.5 of function codes 07.18 ~ 07.21. When the output frequency of the inverter rises above the set value of FDT level, it outputs a valid signal (open collector signal, which is low level after the resistor is pulled up). When the output frequency drops below FDT signal (set value-hysteresis value), it outputs an invalid signal. As shown in the figure below:

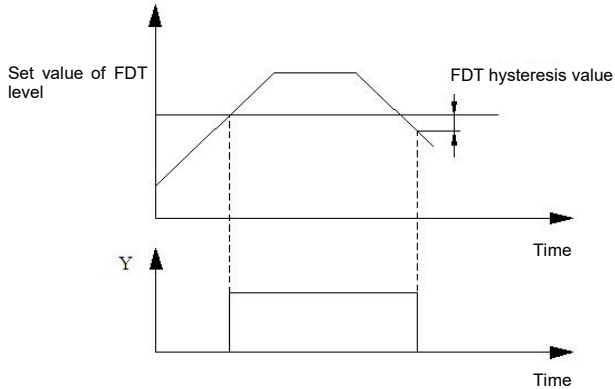

Figure F7-8 Schematic diagram of frequency level detection

07.30	Processing in the Count arrival	3
	0~3	

HV100 Series High Performance Current Vector Inverter

- 0: stop counting and output
- 1: stop counting and continue outputting
- 2: cycle the counting, and stop output
- 3: cycle counting, and continue to output

When the count value of the counter reaches the value, set by function code 07.32, the corresponding action of the inverter is performed.

07.31	Starting condition of Counting	
	0~1	1

- 0: Always start when powered on
- 1: Start when running, will stop when stopping

The above premise is that there is a counting pulse input

07.32	Setting reset value of the counter	
	【07.33】 ~65535	0
07.33	Setting detection value of counter	
	0~ 【07.32】	0

This function code defines the reset value and detection value of the counter. When the counting value of the counter reaches the value, set by function code 07.32, the corresponding multi-function output terminal (counter reset signal output) outputs an valid signal and clears the counter.

When the count value of the counter reaches the value, set by function code 07.33, an valid signal is output at the corresponding multi-function output terminal (counter detection signal output). If counting continues and exceeds the value, set by function code 07.32, the output valid signal will be cancelled when the counter is cleared.

As shown in the following figure, the programmable relay output is set as the reset signal output, and open collector output Y1 set as counter detection output, 07.32 as 8 and 07.33 as 5. When the detection value is 5, Y1 keeps to output an valid signal; When the reset value reaches 8, the relay outputs an valid signal of one pulse period and clears the counter. At the same time, Y1, the relay cancel the output signal.

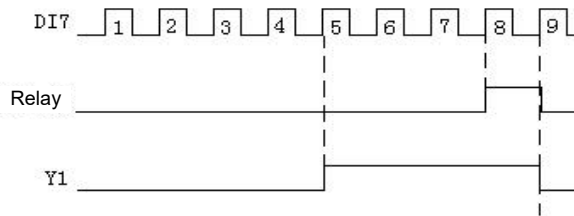

Figure F7-9 Schematic diagram for counter setting of reset and detection

07.34	Processing of Timing arrival	
	0~3	3

- 0: stop timing and output
- 1: stop timing and continue output
- 2: cycle timing, stop output
- 3: cycle counting, continue to output

When the count value of the counter reaches the value, set by function code 07.36, the corresponding action of the inverter is performed.

07.35	Timing starting condition	
	0~1	1

- 0: Always start when powered on
- 1: Start when running, will stop when stopping

07.36	Setting of the timing time	
	0~65535S	0
07.37	Y1 delay time of disconnect	
	0.0~100.0s	0.0

HV100 Series High Performance Current Vector Inverter

07.38	Y2 delay time of disconnect	0.0~100.0s	0.0
	R1 delay time of disconnect	0.0~100.0s	0.0
07.39	R2 delay time of disconnect	0.0~100.0s	0.0
07.40			

008 group -PID control parameters

By setting this parameter group, a complete control system of analog feedback can be formed.

Control system of analog feedback: the setting value is input with AI1, and the physical value of the controlled object is converted into 4 ~ 20mA current, which is input through AI2 of the inverter. The current goes through the built-in PI regulator, so that forms an analog closed-loop control system, as shown in the below figure:

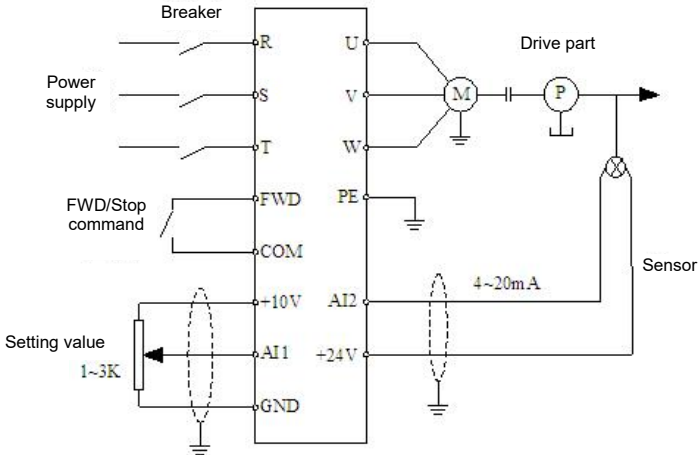

Figure F8-1 Schematic diagram of analog feedback control system

PID regulation functions are as follows:

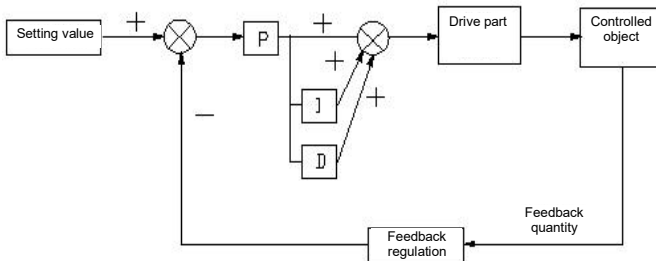

Fig. F8-2 PID regulation schematic diagram

08.00	PID operation mode	0~1	0

0: Automatic

1: manually input through the defined multi-function terminal

08.01	PID setting channel selection	0~6	0

HV100 Series High Performance Current Vector Inverter

0: Number setting

PID setting value is setting in using numbers,through the function code 08.02.

1: AI1

PID setting value is set by external analog signal AI1 (0 ~ 10V/0-20mA).

2: AI2

PID setting value is set by external analog signal AI2 (0 ~ 10V).

3: Pulse setting

PID setting value is given by external pulse signal.

4: RS485 communication

The PID setting value is set by the communication.

5: pressure setting value (MPa)

See 08.25~08.26 for detail

6: Panel potentiometer setting

08.02	Set of digital setting value	
	0.0~100.0%	50.0%

When using analog feedback, this function code can set the setting value of closed-loop control through using the operation panel. But this function is valid only when the digital setting channel of closed-loop is selected (08.01 is 0).

For example, in the closed-loop control system of constant pressure water supply, the setting of this function code should fully consider the counting relationship between the range of the remote pressure gauge and its output feedback signal. For example, the range of the pressure gauge is 0 ~ 10 MPa, which corresponds to the output voltage of 0 ~ 10 V, and we need 6 MPa pressure, so we can set the digital value into 6.00V, so when the PID regulation is stable, the required pressure is 6 MPa.

08.03	Selection of PID feedback channel	
	0~7	0

0: AI1

The feedback value of PID is set by the external electric analog signal AI1.

1: AI2

The feedback value of PID is set by the external analog signal AI2.

2: AI1+ AI2

The feedback value of PID is determined by the sum of AI1 and AI2.

3: AI1-AI2

The feedback value of PID is determined by the difference between AI1 and AI2. When the difference is negative, the feedback value of PID defaults to 0.

4: MAX { AI1, AI2 }

5: MIN { AI1, AI2 }

6: Pulse setting

7: RS485 communication

08.04	Advanced characteristic setting of PID controller	
	0000~101	000

LED bit: PID regulation characteristics

0: positive effect

When the feedback signal is higher than the set value of PID, the output frequency of the inverter is required to decrease (means that the feedback signal is reduced), so that the PID can reach the balance. All that means a positive characteristic. Such as using for tension control of winding machine and constant pressure water supply control.

1: negative effect

When the feedback signal is higher than the set value of PID, the output frequency of inverter is required to rise (that is, the feedback signal is reduced), so that the PID can reach balance. All that means a negative characteristic. Such as tension control of winding machine and central air conditioning control.

LED bit: Proportional-integral control characteristics (reservation)

0: constant proportional-integral control

1: automatic proportional-integral control

LED hundred-digit: integral control characteristic

0: stop integral adjustment when the frequency reaches the upper and lower limits

1: when the frequency reaches the upper and lower limits, continue the integral adjustment

For systems requiring rapid response, it is recommended to cancel the continuous integral adjustment

LED thousand bits: reservation

HV100 Series High Performance Current Vector Inverter

08.05	Proportional gain KP1	
	0.01~100.00s	2.50
08.06	Integral time Ti1	
	0.01~10.00s	0.10
08.07	Differential time Td1	
	0.01~10.00s	0.00

0.00: No derivative adjustment

Proportional gain (Kp):

The adjustment intensity of the whole PID regulator is determined by this. And the greater the P is, the greater the adjustment intensity is. But if in too large state, there is easy to produce oscillation.

When the feedback deviates from the set value, the deviation and output become the regulating value of proportion. If the deviation is constant, the regulating value is also constant. Proportional adjustment can quickly show out the feedback changes, but it is impossible to achieve error-free control by proportional control alone. The larger the proportional gain is, the faster the adjustment speed of the system will be, but if too large, oscillation will occur. The adjustment method is to set the integration time for a longer time, and the differentiation time for zero, then use proportional control to make the system run. With changing the size of the given quantity, it can observe the stable deviation (static difference) between the feedback signal and the set value. If the static difference changes in the direction of the set value (for example, if the set value is increased and the feedback value is always less than the set value after the system is stable), then increasing the proportional gain continues. Otherwise reduce the proportional gain, and repeat the above process until the static difference is relatively small (It's hard to make it without any static errors)

Integral time (ti):

Determine the speed of PID regulators to do the integral adjustment of deviation.

When the feedback deviates from the set value, the output adjustment value need to continuously accumulate. And if the deviation persists, the adjustment value continuously increases until there is no deviation. Integral regulator can validly eliminate static difference. If the integral regulator is too strong, there will be repeated overshoot, which will make the system oscillate. Generally, the adjustment of integration time parameters is from large to small, and the integration time is gradually adjusted, while the effect of system adjustment is observed, all until the stable speed of the system meets the requirements.

Differential time (Td):

Determine the strength of PID regulator to adjust the rate of deviation change.

When the feedback changes with the set deviation, the rate of deviation change and output become the regulating value of proportion, which is only related to the direction and magnitude of deviation change, but has nothing to do with the direction and magnitude of deviation itself. when the feedback signal changes, the function of derivative adjustment is to adjust according to the changing trend of it, so as to restrain the change of it. Please use derivative regulator with caution, because derivative regulator is easy to amplify the interference of the system, especially the interference from large changing frequency.

08.08	Sampling period T	
	0.01~100.00s	0.10

0.00: Automatic

Sampling period is the period to sample the feedback value, and the regulator operates once in each sampling period. The larger the sampling period, the slower the response, but the better the suppression effect on interference signal, so it is generally unnecessary to set it.

08.09	Deviation limit	
	0.0~100.0%	0.0%

The deviation limit is the ratio of the set value and the absolute value, which means the absolute deviation value between system feedback value and the set value. When the feedback value is within the deviation limit, PID control does not work. As shown in the figure below, setting a reasonable deviation limit can prevent the system from frequently adjusting near the target value, which is helpful to improve the stability of the system.

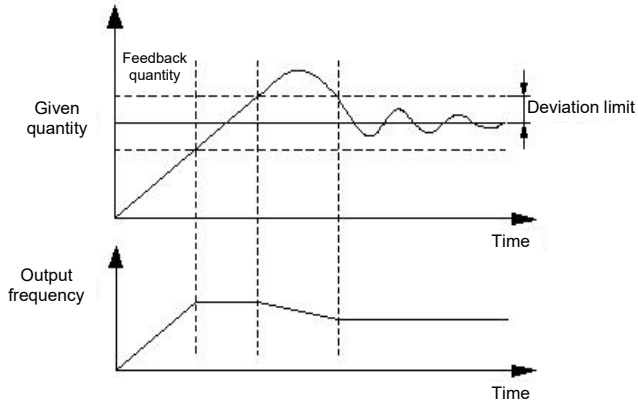

Figure F8-3 Schematic diagram of deviation limit

08.10	Closed loop preset frequency	
	0.00 ~ upper limit frequency	0.00
08.11	Preset frequency holding time	
	0.0 ~ 3600.0s	0.0

This function code defines the frequency and running time of inverter before PID is put into operation when PID control is valid. In some control systems, in order to make the controlled object reach the preset value quickly, the inverter forcibly outputs a certain frequency value of 08.10 and a frequency holding time of 08.11 according to the setting of this function code. That is, when the control object is close to the control target, the PID controller is put into operation to improve the response speed. As shown in the figure below:

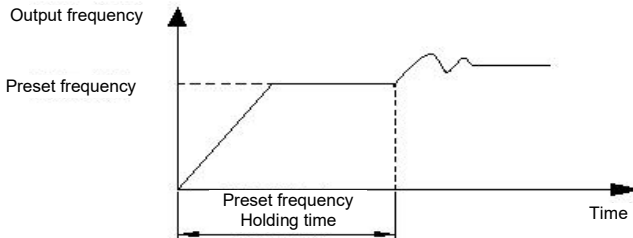

Figure F8-4 Schematic diagram of closed-loop preset frequency operation

08.12	Sleep mode	
	0~2	1

0: Invalid

1: Sleep when feedback pressure exceeds or falls below sleep threshold

This mode is the first sleep mode of PID, as shown in Figure F8-5

2: Sleep when feedback pressure and output frequency are stable

This mode is the second sleep mode of PID. There are two situations (as shown in Figure F8-6):

1) if the feedback value is less than the given value and greater than the given value $\times (1 - \text{set deviation } [08.14])$, the change of output frequency is within 6%, and then sleep after the sleep delay time [08.17].

2) If the feedback value rises above the given value, keep the sleep delay time [08.17] and then go to sleep. On the contrary, if the feedback value drops below the awakening threshold [08.16], wake up immediately.

08.13	Selection of sleep shutdown mode	
	0~1	0

HV100 Series High Performance Current Vector Inverter

0: deceleration and shutdown

1: free stop

08.14	Deviation between feedback and set pressure when entering sleep	
	0.0~10.0%	0.5%

This function parameter is only valid for the second sleep mode.

08.15	Sleep threshold	
	0.00~200.0%	100.0%

This threshold is the percentage of the given pressure, and this function parameter is only valid for the first sleep mode relative to the setting.

08.16	Awakening threshold	
	0.00~200.0%	90.0%

08.15 defines the feedback limit when the inverter enters the sleep state from the working state. If the actual feedback value is greater than the set value, and the frequency output by the inverter reaches the lower limit frequency, the inverter will go to sleep after the delay waiting time defined in 08.17 (i.e. running at zero speed).

08.16 defines the feedback limit of inverter from sleeping state to working state. When PID polarity selects positive characteristic, if the actual feedback value is less than the set value (or when PID polarity selects negative characteristic, if the actual feedback value is greater than the set value), the inverter will get out of sleep and start working after the delay waiting time defined in 08.18.

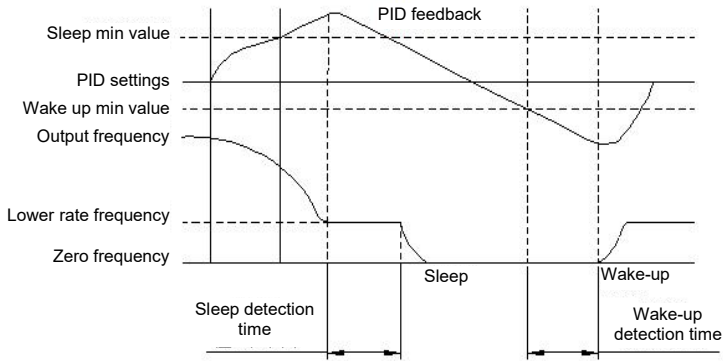

Figure F8-5 Schematic diagram of the first sleep mode

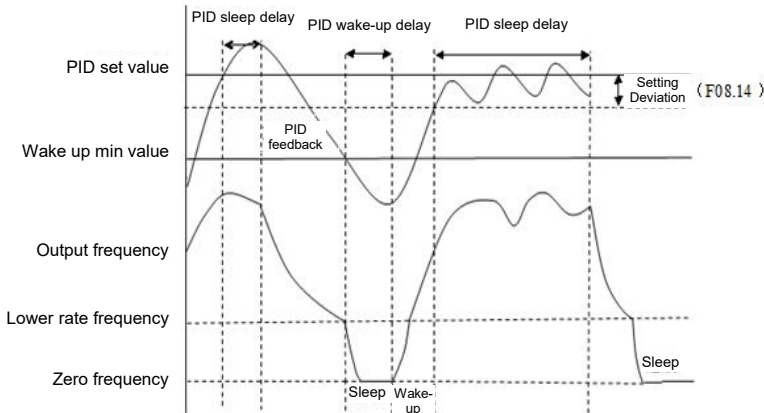

Figure F8-6 Schematic diagram of the second sleep mode

HV100 Series High Performance Current Vector Inverter

08.17	Sleep delay time	100.0
	0.0~600.0S	
08.18	Wake delay time	5.0
	0.0~600.0S	
08.19	Proportional gain KP2	5.00
	0.01~100.00s	
08.20	Integration time Ti2	0.05
	0.01~10.00s	
08.21	Differential time Td2	0.00
	0.01~10.00s	
08.22	Upper limit cut-off frequency of PID	50.00
	【08.23】 ~300.00Hz	
08.23	Lower limit cut-off frequency of PID	0.00
	-300.00Hz~ 【08.22】	
08.24	Sleep frequency	0.00
	0.00Hz~ 【00.13】	

009 group-simple PLC, multi-speed

09.00	Selection of PLC operation mode	0
	0~3	

0: Stop after single cycle

The inverter stops automatically after completing a single cycle, and it needs to give the running command again before starting. If the running time of a certain stage is 0, the running time skips the stage and goes directly to the next stage. As shown in the figure below:

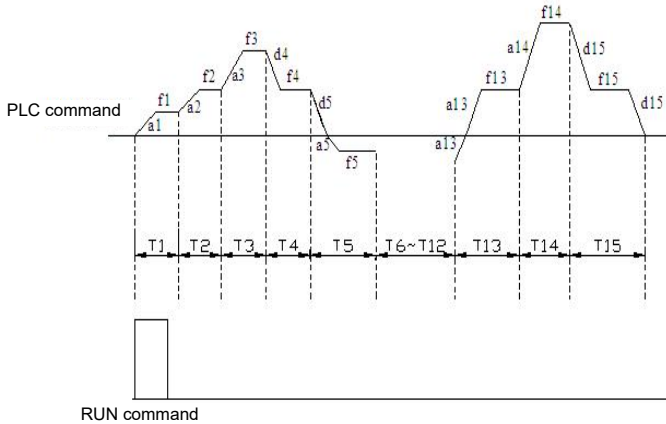

Fig. F9-1 Schematic diagram of PLC shutdown after single cycle

1: Keep the final value running after a single cycle

After completing a single cycle, the inverter automatically keeps the running frequency and direction of the last section to keep running. As shown in the figure below:

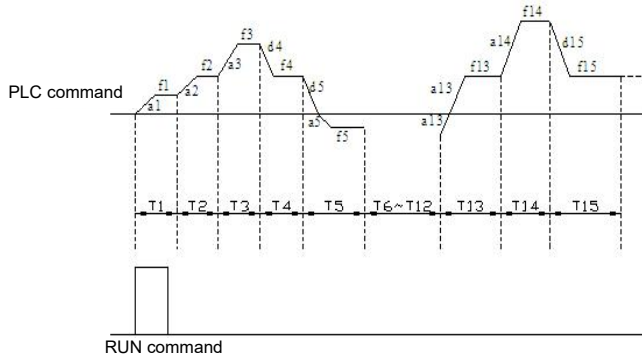

Fig. F9-2 Schematic diagram of PLC maintenance after single cycle

2: Finite continuous cycle

The inverter determines the cycle times of PLC operation according to the limited number of continuous cycles set in 09.04, and stops when the cycle times are reached. 09.04=0, the inverter is not running.

3: Continuous circulation

After completing one cycle, the inverter will automatically start the next cycle, and will not stop until there is a stop command. As shown in the figure below:

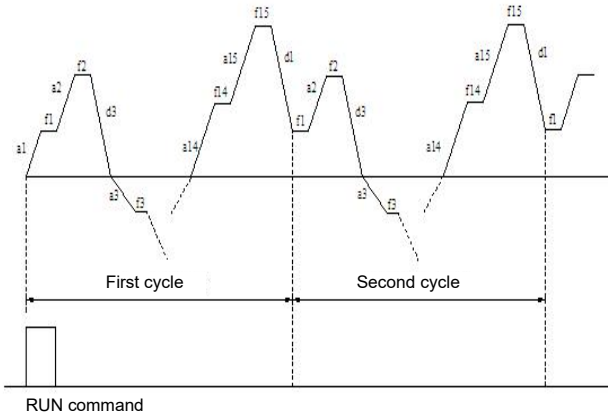

Figure F9-3 Schematic diagram of PLC continuous cycle

09.01	Operation mode of PLC	
	0~1	0

0: Automatic

1: Manually operation through the defined multi-function terminal

09.02	Memory of PLC running power failure	
	0~1	0

0: Not store

Do not remember the PLC running state when power is cut off, and restart after power-on to start running from the first section.

1: Remember the stage and frequency of power-down time

Memorize PLC running state when power is cut off, including power-off time stage, running frequency and running time. Start again after power-on, automatically enter this stage, and continue to run for the rest of the time at the frequency defined by this stage.

09.03	PLC starting mode	
	0~2	0

HV100 Series High Performance Current Vector Inverter

0: Restart from the first stage

Stop during operation (caused by shutdown command, fault or power failure), and start operation from the first section after restart.

1: Start from the stage of shutdown (failure) time

In case of shutdown during operation (caused by shutdown command, fault or power failure), the inverter automatically records the running time of the current stage, and automatically enters this stage after restarting, and continues to run for the remaining time at the frequency defined by this stage, as shown in the following figure:

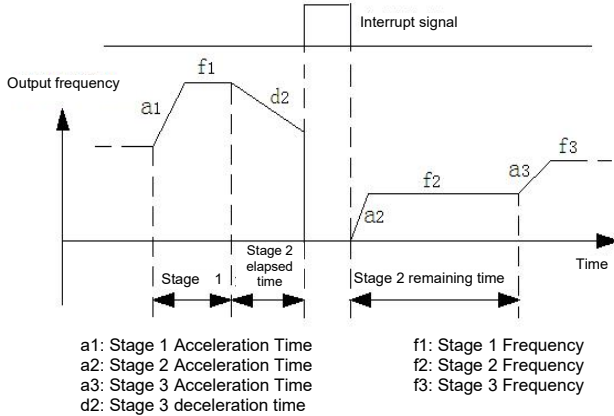

Fig. F9-4 PLC starting mode 1

2: Start from the stage and frequency of shutdown (failure) time

In case of shutdown during operation (caused by shutdown command, fault or power failure), the inverter not only automatically records the running time at the current stage but also records the running frequency at the shutdown time, and then recovers to the running frequency at the shutdown time after starting again, and the remaining phases of the frequency run, as shown in the following figure:

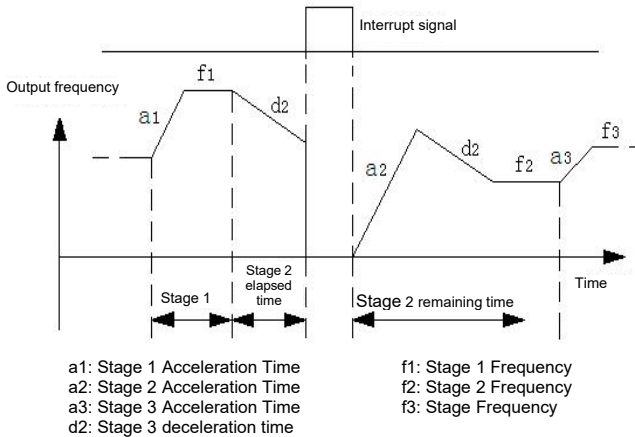

Fig. F9-5 PLC starting mode 2



Notes:

The difference between mode 1 and mode 2 is that mode 2 memorizes the operating frequency of one shutdown time more than mode 1, and continues to operate from this frequency after restarting.

HV100 Series High Performance Current Vector Inverter

09.04	Finite number of continuous cycles	
	1~65535	1

09.05	Selection of PLC running time unit	
	0~1	0

0: s

1: min

09.06	Multi speed frequency 0	
	-upper limit frequency ~ upper limit frequency	5.00
09.07	Multi speed frequency 1	
	-upper limit frequency ~ upper limit frequency	10.00
09.08	Multi speed frequency 2	
	-upper limit frequency ~ upper limit frequency	15.00
09.09	Multi speed frequency 3	
	-upper limit frequency ~ upper limit frequency	20.00
09.10	Multi speed frequency 4	
	-upper limit frequency ~ upper limit frequency	25.00
09.11	Multi speed frequency 5	
	-upper limit frequency ~ upper limit frequency	30.00
09.12	Multi speed frequency 6	
	-upper limit frequency ~ upper limit frequency	40.00
09.13	Multi speed frequency 7	
	-upper limit frequency ~ upper limit frequency	50.00
09.14	Multi speed frequency 8	
	-upper limit frequency ~ upper limit frequency	0.00
09.15	Multi speed frequency 9	
	-upper limit frequency ~ upper limit frequency	0.00
09.16	Multi speed frequency 10	
	-upper limit frequency ~ upper limit frequency	0.00
09.17	Multi speed frequency 11	
	-upper limit frequency ~ upper limit frequency	0.00
09.18	Multi speed frequency 12	
	-upper limit frequency ~ upper limit frequency	0.00
09.19	Multi speed frequency 13	
	-upper limit frequency ~ upper limit frequency	0.00
09.20	Multi speed frequency 14	
	-upper limit frequency ~ upper limit frequency	0.00
09.21	Multi speed frequency 15	
	-upper limit frequency ~ upper limit frequency	0.00

The sign of multi-speed determines the direction of operation, and negative indicates the opposite direction of operation. The frequency input mode is set by 00.07=6, and the start-stop command is set by 00.06.

09.22	0 speed acceleration and deceleration time	
	0~3	0
09.23	0 speed running time	
	0.0~6553.5S(M)	0.0
09.24	1st speed acceleration and deceleration time	

HV100 Series High Performance Current Vector Inverter

	0~3	0
09.25	1st speed running time	
	0.0~6553.5S(M)	0.0
09.26	2nd speed acceleration and deceleration time	
	0~3	0
09.27	2nd speed running time	
	0.0~6553.5S(M)	0.0
09.28	3rd speed acceleration and deceleration time	
	0~3	0
09.29	3rd speed running time	
	0.0~6553.5S(M)	0.0
09.30	4th speed acceleration and deceleration time	
	0~3	0
09.31	4th speed running time	
	0.0~6553.5S(M)	0.0
09.32	5th speed acceleration and deceleration time	
	0~3	0
09.33	5th speed running time	
	0.0~6553.5S(M)	0.0
09.34	6th speed acceleration and deceleration time	
	0~3	0
09.35	6th speed running time	
	0.0~6553.5S(M)	0.0
09.36	7th speed acceleration and deceleration time	
	0~3	0
09.37	7th speed running time	
	0.0~6553.5S(M)	0.0
09.38	8th speed acceleration and deceleration time	
	0~3	0
09.39	8th speed running time	
	0.0~6553.5S(M)	0.0
09.40	9th speed acceleration and deceleration time	
	0~3	0
09.41	9th speed running time	
	0.0~6553.5S(M)	0.0
09.42	10th speed acceleration and deceleration time	
	0~3	0
09.43	10th speed running time	
	0.0~6553.5S(M)	0.0
09.44	11th speed acceleration and deceleration time	
	0~3	0
09.45	11th speed running time	
	0.0~6553.5S(M)	0.0
09.46	12th speed acceleration and deceleration time	
	0~3	0
09.47	12th speed running time	
	0.0~6553.5S(M)	0.0
09.48	13th speed acceleration and deceleration time	
	0~3	0
09.49	13th speed running time	
	0.0~6553.5S(M)	0.0
09.50	14th speed acceleration and deceleration time	

HV100 Series High Performance Current Vector Inverter

	0~3	0
09.51	14th speed running time	
	0.0~6553.5S(M)	0.0
09.52	15th speed acceleration and deceleration time	
	0~3	0
09.53	15th speed running time	
	0.0~6553.5S(M)	0.0

The above-mentioned function code is used to set the acceleration and deceleration time and running time of programmable multi-stage speed. The acceleration and deceleration time of 16-segment speed can be set by the acceleration and deceleration time of 1 ~ 4 segments respectively; The 16-segment running time can be set separately by the X-segment running time.

16-speed acceleration and deceleration time is set to 0, representing acceleration and deceleration time 1 (00.16 ~ 00.17); Set 1, 2 and 3 to represent acceleration and deceleration time 2 (01.13 ~ 01.14), 3 (01.15 ~ 01.16) and 4 (01.17 ~ 01.18), respectively. (X take 0~15)。



Notes:

- 1: when the running time of a certain stage of 1: PLC is set to 0, this stage is invalid.
- 2: PLC process can be put into operation, suspended, reset, etc. through terminals, please refer to F7 group terminal function definition.
- 3: The running direction of 3: PLC stage is determined by the frequency plus or minus and the running command. The actual running direction of the motor can be changed in real time by the external direction command.

09.54	Reservation	
	Reservation	0

09.55	Swing frequency control	
	0~1	0

0: prohibited

1: valid

09.56	Swing frequency operation mode	
	0~1	0

0: Automatic

1: Manually operation through the defined multi-function terminal

09.56 select 1. When the multi-function X terminal selects function 35, the Swing frequency is put in during operation, otherwise the Swing frequency is invalid.

09.57	Swing amplitude control	
	0~1	0

0: fixed swing

The reference value of swing is the maximum output frequency of 00.12.

1: variable swing

The reference value of the swing is the given channel frequency.

09.58	Swing frequency stop/start mode selection	
	0~1	0

0: start according to the state memorized before shutdown

1: restart starting

09.59	Power-down storage of frequency swing state	
	0~1	0

0: store

1: do not store

When the power is off, the Swing state parameters are stored. This function is only valid when the mode of "Start according to the state memorized before shutdown" is selected.

09.60	Swing preset frequency	
-------	------------------------	--

HV100 Series High Performance Current Vector Inverter

09.61	0.00Hz ~ ~ upper limit frequency	10.00
	Swing preset frequency waiting time	
	0.0~3600.0s	0.0

The above function codes define the operating frequency of the inverter before entering the swing frequency operation mode or when leaving the swing frequency operation mode and the running time at this frequency point. If the function code 09.61≠0 (swing frequency preset frequency waiting time) is set, the inverter directly enters the swing frequency preset frequency operation after starting, and enters the swing frequency mode after the swing frequency preset frequency waiting time.

09.62	Swing amplitude	
	0.0~100.0%	0.0%

The Swing amplitude is determined by 09.57, and its reference is determined by 09.57. If 09.57=0, then the Swing Aw = the maximum output frequency *09.62

If 09.57=1, then swing

AW = given channel frequency *09.62.



Tips:

- 1: The swing frequency is restricted by the upper and lower frequencies. If it is set improperly, the swing frequency will not work properly.
- 2: JOG, PID control mode, swing frequency automatically fails.

09.63	Jump frequency	
	0.0 ~ 50.0% (relative swing frequency amplitude)	0.0%

This function code refers to the amplitude of rapid decline after the frequency reaches the upper limit frequency of the swing frequency, and of course it also refers to the amplitude of rapid rise after the frequency reaches the lower limit frequency of the swing frequency.

If it is set to 0.0%, there is no sudden jump frequency.

09.64	Swing frequency rise time	
	0.1~3600.0s	5.0
09.65	Swing frequency falling time	
	0.1~3600.0s	5.0

This function code defines the running time from the lower limit frequency to the upper limit frequency and from the upper limit frequency to the lower limit frequency.

Swing frequency control is suitable for textile, chemical fiber and other industries, as well as occasions requiring traverse and winding functions. Its typical work is shown in Figure F9-6.

Generally, the swing frequency process is as follows: first accelerate to the preset swing frequency (09.60) according to the acceleration time, wait for a period of time (09.61), then transition to the center frequency according to the acceleration and deceleration time, and then set the swing frequency amplitude (09.62), sudden jump frequency (09.63), swing frequency rising time (09.64) and swing frequency falling time.

HV100 Series High Performance Current Vector Inverter

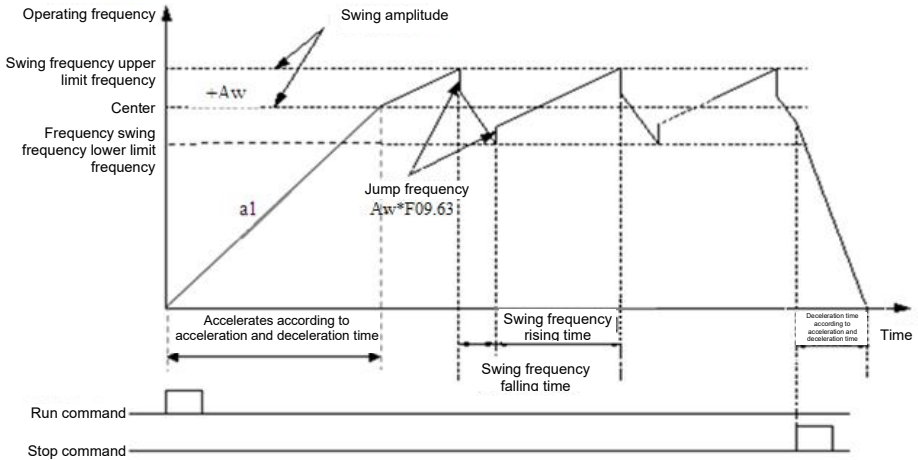

Fig. F9-6 Schematic diagram of Swing frequency



Tips:

- 1: the center frequency can be given by digital given frequency, analog quantity, pulse, PLC or multi-speed etc.
- 2: Automatic cancellation of frequency swing during JOG and closed-loop operation.
- 3: PLC runs with swing frequency. When switching between PLC sections, the swing frequency fails. After transitioning to the set frequency of PLC according to the acceleration and deceleration setting of PLC stage, the swing frequency starts, and when stopping the machine, it slows down according to the deceleration time of PLC stage.

09.66	Reservation	
	Reservation	0

09.67	Fixed length control	
	0~1	0

0: prohibited

1: valid

09.68	Set length	
	0.000~65.535(KM)	0.000
09.69	Actual length	
	0.000~65.535(KM)	0.000
09.70	Length magnification	
	0.100~30.000	1.000
09.71	Length correction coefficient	
	0.01~1.000	1.000
09.72	Measure the circumference of shaft	
	0.10~100.00CM	10.00
09.73	Number of pulses per rotation of shaft (DI6)	
	1~65535	1000

This set of functions is used to realize the fixed-length shutdown function.

The inverter inputs counting pulses from the terminal (HDI is defined as function 47), and the calculated length is obtained according to the number of pulses per revolution of the speed measuring shaft (09.73) and the circumference of the shaft (09.72).

Calculation length = count pulse number ÷ Number of pulses per revolution × Measure the circumference of shaft

The calculated length is corrected by length magnification (09.70) and length correction coefficient (09.71), and the actual length is obtained.

HV100 Series High Performance Current Vector Inverter

Actual length = calculated length × Length magnification + Length correction factor

When the actual length (09.69) ≥ the set length (09.68), the inverter will automatically issue a shutdown instruction to stop. The actual length (09.69) should be cleared or modified before running again < Set the length (09.68), otherwise it will not start.

Tips:

The actual length can be cleared with multi-function input terminal (the input terminal is defined as 46 functions, and the length count is cleared). If the terminal is valid, the previous length count value will be cleared, and the actual length can be counted and calculated normally after the terminal is disconnected.

The actual length is 09.69, which is automatically stored when power is cut off.

When the set length 09.68 is 0, the fixed-length shutdown function is invalid, but the length calculation is still valid.

Application example of fixed-length shutdown function:

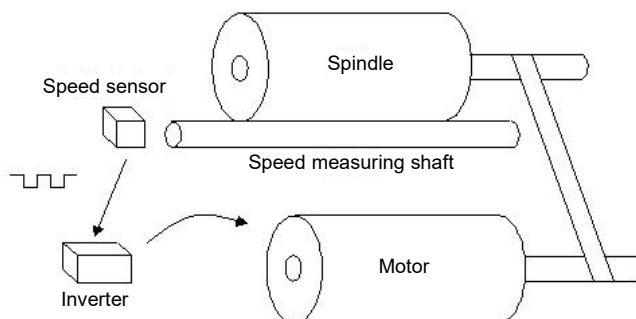

Figure F9-7 Example of Long Stop Function

In Figure F9-7, the inverter drives the motor, which drives the spindle shaft to rotate through the conveyor belt, and the speed measuring shaft contacts the spindle, so that the linear speed of the spindle is detected and transmitted to the inverter through the counting terminal in the form of pulses. The inverter detects the pulses and calculates the actual length. When the actual length is greater than or equal to the set length, the inverter automatically stops.

010 Group- Protective parameters

10.00	Motor Overload protection selection	
	0~2	1

0: prohibited

No motor overload protection (use it with caution).

1: Ordinary motor (electronic thermal relay mode, low-speed compensation)

due to the poor heat dissipation effect of ordinary motor in low-speed operation, the corresponding motor thermal protection

value should also be adjusted appropriately. The low-speed compensation characteristic

here is to lower the overload protection threshold of motor whose operating frequency is lower than 30Hz.

2. Variable frequency motor (electronic thermal relay mode, low speed without compensation)

Due to the heat dissipation of the frequency conversion special motor is not affected by the rotating speed, there is no need to adjust the protection value during low-speed operation.

10.01	Motor overload protection coefficient	
	20.0% ~ 120.0%	100.0%

To implement valid overload protection for different types of load motors, it is necessary to set the overload protection coefficient of motors reasonably and limit the maximum current allowed by the inverter. The motor overload protection coefficient is the percentage of the rated current value of the motor to the rated output current value of the inverter.

When the inverter drives the motor with matching power level, the motor overload protection coefficient can be set to 100%. As shown in the figure below:

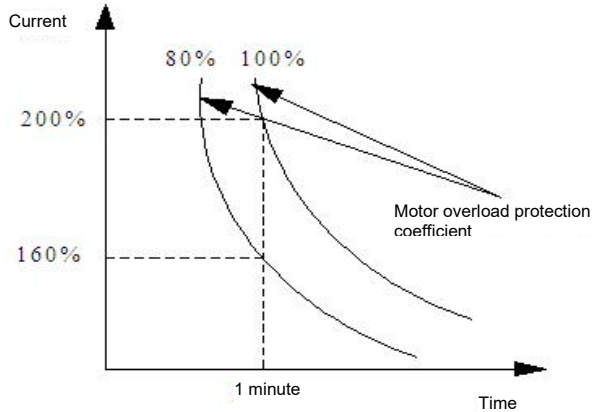

Figure 010-1 Motor overload protection curve

When the capacity of inverter is larger than that of motor, in order to implement valid overload protection for load motors of different specifications, it is necessary to set the overload protection coefficient of motor reasonably as shown in the following figure:

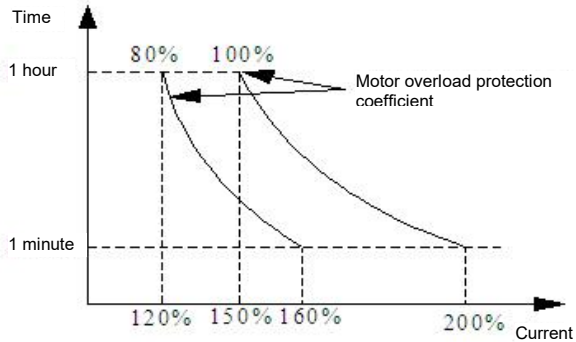

Figure 010-2 Schematic diagram of motor overload protection coefficient setting

The motor overload protection coefficient can be determined by the following formula:

$$\text{Overload protection coefficient of motor} = \frac{\text{maximum allowable load current}}{\text{rated output current of inverter}} \times 100\%$$

Generally, the maximum load current refers to the rated current of the load motor. Adjustment of protection value in line.

10.02	Undervoltage protection action selection	
	0~1	0

0: prohibited

1: allowed (undervoltage is regarded as fault)

10.03	Undervoltage protection level	
	220V: 180~280V 200V	Model setting
	380V: 330~480V 350V	

This function code specifies the allowable lower limit voltage of DC bus when the inverter works normally.

⚠ Notes:

When the grid voltage is too low, the output torque of the motor will be decreased. For constant power load and constant torque load, too low grid voltage will increase the input and output current of inverter, thus reducing the reliability of inverter operation. Therefore, when operating for a long time under low grid voltage, the inverter power needs to be derated.

HV100 Series High Performance Current Vector Inverter

10.04	Overvoltage limit level		Model setting
	220V: 350~390V	370V	
	380V: 550~780V	660V	

Overvoltage limit level defines the operating voltage during voltage stall protection.

10.05	Voltage limit coefficient during deceleration		Model setting
	0 ~ 100 0: Overvoltage stall protection is invalid		

During deceleration, the greater this value, the stronger the ability to suppress Overvoltage.

10.06	Current limit level (only V/F mode is valid)		Model setting
	G type: 80% ~ 200% * rated current of inverter	160%	
	P type: 80% ~ 200% * rated current of inverter	120%	

The current limiting level defines the current threshold of automatic current limiting operation, and its set value is the percentage relative to the rated current of the inverter.



Notes:

In ordinary VF mode, limit amplitude with 10.06 during acceleration and constant speed operation; In vector VF mode, the amplitude is limited by 10.06 during accelerated operation and infinite amplitude is processed during constant speed operation; In vector mode, the amplitude limit in constant speed operation is only related to 04.20 ~ 04.21.

10.07	Selection of current limit in weak magnetic field		0
	0~1		

0: limited by the current limit level of 10.06

When the output frequency is within 50Hz, the amplitude is limited by 10.06.

1: limited by the current limit level converted from 10.06

When the output frequency is greater than 50Hz, the amplitude is limited by the current converted from 10.06.

10.08	Current limiting coefficient during acceleration		Model setting
	0 ~ 100 0: Acceleration current limit is invalid		

In the process of acceleration, the greater this value, the stronger the ability to suppress overcurrent.

10.09	Current limiting coefficient during constant speed		40
	0~5000		

0 ~ 100 is automatic frequency reduction, and the larger the coefficient, the faster the frequency reduction rate; 101 ~ 5000 means manual frequency reduction, 101 means 0.01Hz /S, and so on, and 5000 means 50.00/s.

10.10	Drop load detection time		5.0
	0.1S~60.0S		
10.11	Drop load detection level		0.0%
	0.0 ~ 100.0% * rated current of inverter		

0: the off load drop detection is invalid

The off load detection level (10.11) defines the current threshold for the drop load action, which is set as a percentage relative to the inverter rated current.

The off load detection time (10.10) defines that the output current of the inverter is less than the load drop detection level (10.11) for more than a certain time, and then the load drop signal is output.

The off-load status is valid, that is, the working current of the inverter is less than the off-load detection level and the holding time exceeds the off-load detection time.

HV100 Series High Performance Current Vector Inverter

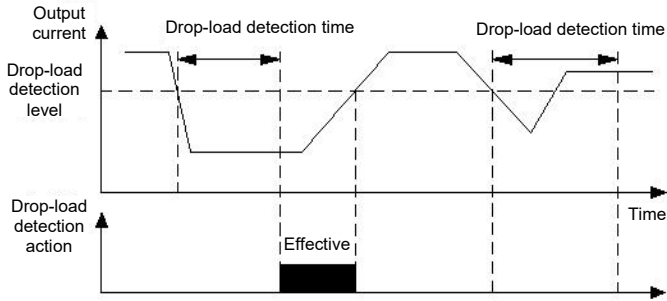

Figure 010-3 Schematic diagram of drop load detection

10.12	Overload pre-alarm level		Model setting
	G type: 20% ~ 200% * rated current of inverter	160%	
	P type: 20% ~ 200% * rated current of inverter	120%	

Overload pre-alarm mainly monitors overload condition before overload protection of inverter. Overload pre-alarm level defines the current threshold of overload pre-alarm action, and its set value is relative to the rated current of inverter.

10.13	Overload pre-alarm delay time		10.0
	0.0 ~ 300s		

Overload pre-alarm delay defines the delay time between the output current of inverter continuously exceeding the amplitude of overload pre-alarm level (10.12) and the output of overload pre-alarm signal.

⚠️Notes:

By setting the parameters 10.12 and 10.13, when the output current of the inverter is greater than the overload pre-alarm level amplitude (10.12), the inverter outputs the pre-alarm signal after delay (10.13), that is, the keypad displays A-09.

10.14	Temperature detection threshold		65.0℃
	0.0℃ ~ 90.0℃		

See function description No.51 in parameter 07.18 ~ 07.21 for details.

10.15	Selection of input and output phase lose protection		Model setting
	0~3		

0: all prohibited

1: input prohibited, output allowed

2: Input allowed, output prohibited

3: All allowed

Manufacturer default option 1 for up to 7.5kW and above 11kW Manufacturer default option 3.

10.16	Input phase loss protection delay time		1.0
	0.0S ~ 30.0S		

When the input phase lose protection is selected to be valid and the input phase lose fault occurs, the inverter will protect E-12 after the time defined in 10.16, and stop freely.

10.17	Output phase lose protection detection reference		50%
	0% ~ 100% * rated current of inverter		

When the actual output current of the motor is greater than the rated current * [10.17], if the output phase failure protection is valid, after a delay time of 5S, the inverter protection acts [E-13] and stops freely.

10.18	Output current unbalance detection coefficient		1.00
	1.00 ~ 10.00		

HV100 Series High Performance Current Vector Inverter

If the ratio of the maximum value to the minimum value in the three-phase output current is greater than this coefficient, and the duration exceeds 10 seconds, the inverter will report the output current imbalance fault E-13. When 10.08 = 1.00, the output current imbalance detection is invalid.

10.19	Reservation	
	Reservation	0
10.20	Treatment of PID feedback disconnection	
	0~3	0

0: no action

1: Alarm and keep running at the frequency of disconnection time

2: Protective action and free parking

3: Alarm and slow down to zero speed according to the set mode

10.21	Feedback disconnection detection value	
	0.0~100.0%	0.0%

The maximum value given by PID is taken as the upper limit value of feedback disconnection detection value. In the feedback disconnection detection time, when the feedback value of PID is continuously less than the feedback disconnection detection value, the inverter will make corresponding protection actions according to the setting of 10.20.

10.22	Feedback disconnection detection time	
	0.0~3600.0S	10.0

Feedback the duration after disconnection and before protection action.

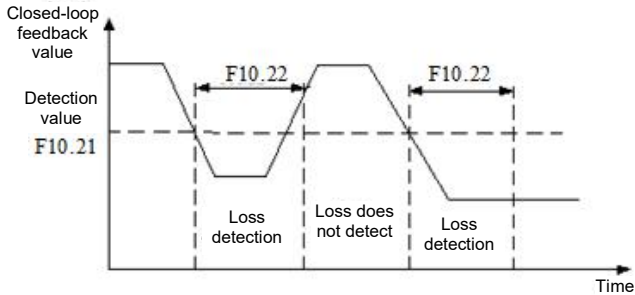

Figure 010-4 Closed-loop feedback loss detection timing diagram

10.23	Setting of FDT1 current detection level	
	0.0~200.0%	0.0

See function No.62 in 07.18 ~ 07.21 for details.

10.24	Selection of RS485 communication abnormal action	
	0~2	1

0: protection action and free stop

1: Alarm and maintain the status quo to continue running

2: Alarm and shut down according to the set shutdown mode

10.25	RS485 communication timeout detection time	
	0.0~100.0s	5.0

If RS485 communication fails to receive the correct data signal within the time interval defined by this function code, it is considered that RS485 communication is abnormal, and the inverter will make corresponding actions according to the setting of 10.24. When this value is set to 0.0, RS485 communication timeout detection is not performed.

10.26	Keypad communication abnormal action selection	
	0~2	1

HV100 Series High Performance Current Vector Inverter

0: protection action and free stop

1: Protect actions and maintain the status quo to continue running

2: Protection action and shutdown according to the set shutdown mode

10.27	Keypad communication timeout check-out time	
	0.0~100.0s	1.0

If the keypad communication fails to receive the correct data signal within the time interval defined by this function code, it is considered that the keypad communication is abnormal, and the inverter will make corresponding actions according to the setting of 10.26.

10.28	EEPROM reading and writing error action selection	
	0~1	0

0: protection action and free stop

1: Alarm and continue running

10.29	Motor overload protection threshold	
	0 ~ 200% * rated current of motor	150%
10.30	Motor overload protection detection time	
	0~60000S	100

When 10.00 ten bits are 2, the output current reaches the overload protection threshold of the inverter (10.31), and then delays the overload protection detection time of the inverter (10.32), and then reports the overload of the inverter E-09.

10.31	Inverter overload protection threshold	
	0 ~ 200% * rated current of inverter	150%
10.32	Inverter overload protection detection time	
	0~60000S	60

When 10.00 ten bits are 2, the output current reaches the overload protection threshold of the inverter (10.31), and then delays the overload protection detection time of the inverter (10.32), and then reports the overload of the inverter E-09.

10.33	OC and module fault limit reset times	
	0~9999	5

When the failure times of OC and module exceed this set value, it needs to be powered on again before resetting.

10.34	Selection of encoder frequency modulation start bit	
	0~3	1

0: LED bits

1: LED ten bits

2: LED hundred bits

3: LED thousand bits

10.35	Reserved	
	0	0

011 Group-RS485 communication parameters

11.00	Protocol selection	
	0~1	0

Communication protocol selection

0:MODBUS

1:Automatic

11.01	Local address	
	0~247	1

0: Broadcast address

1~247:Slave station

HV100 Series High Performance Current Vector Inverter

During 485 communication, this function code is used to identify the address of the inverter.



Notes:

11.01 set 0 as the broadcast address, which can only receive and execute the commands of the upper computer, but will not answer the upper computer.

11.02	Communication baud rate setting	
	0~5	3

0:2400BPS
 1:4800BPS
 2:9600BPS
 3:19200BPS
 4:38400BPS
 5:115200BPS

This function code is used to define the data transmission rate between the upper computer and the inverter. The baud rate set by the upper computer and the inverter should be consistent, otherwise the communication cannot be carried out. The greater the baud rate is set, the faster the data communication is. However, setting too much will affect the stability of communication.

11.03	Data format	
	0~5	0

0: No check(N, 8, 1)for RTU
 1:Parity check (E, 8, 1)for RTU
 2: Odd check (0,8,1) for RTU
 3: No check (N, 8, 2)for RTU
 4: Parity check (E, 8, 1)for RTU
 5: Odd check (0,8,2) for RTU

Note: ASCII mode is temporarily reserved

The data format set by the upper computer and the inverter should be consistent, otherwise normal communication will not be possible.

11.04	Local machine response delay	
	0~200ms	5

This function code defines the intermediate time interval between receiving the data frame of the inverter and sending the response data frame to the upper computer. If the response time is less than the system processing time, the system processing time shall prevail. If the delay is greater than the system processing time, after the system processes the data, it will wait for a delay until the response delay time expires before sending the data to the upper computer.

11.05	Transmission response processing	
	0~1	0

0: Write operation has response

The inverter responds to all read and write commands of the upper computer.

1: Write operation does not respond

The inverter responds to all the read commands of the upper computer, but does not respond to the write commands, so as to improve the communication efficiency.

11.06	Proportional linkage coefficient	
	0.01~10.00	1.00

This function code is used to set the weight coefficient of the frequency command received by inverter as slave through the RS485 interface. The actual operating frequency of the machine is equal to the value of this function code multiplied by the frequency setting command value received through the RS485 interface. In linkage control, this function code can set the ratio of operating frequency of multiple inverters.

11.07	Communication function selection	
	00~21	00

LED bits: Communication mode selection

HV100 Series High Performance Current Vector Inverter

0: General model

1~4: Reserved

LED ten bits: Broadcast frequency source selection

0: Host set frequency

1: Host frequency source A

2: Host frequency source B

LED hundred bits: Reserved

LED thousand bits: Reserved

11.08	Communication display selection	
	0000~4444	000

LED bits: Communication bus voltage display selection

0: Normal display

1: Magnify 10 times

2: Magnify 100 times

3: Shrink 10 times

4: Shrink 100 times

Led ten bits: Communication current display selection

0: Normal display

1: Magnify 10 times

2: Magnify 100 times

3: Shrink 10 times

4: Shrink 100 times

LED hundred-digit: Operation frequency display selection

0: Normal display

1: Magnify 10 times

2: Magnify 100 times

3: Shrink 10 times

4: Shrink 100 times

LED thousand bits: Reserved

012 Group -Advanced functions and performance parameters

12.00	Energy consumption braking function setting	
	0~2	1

0: Invalid

1: Valid in the whole process

2: Valid only when decelerating

12.01	Energy consumption braking starting voltage		Model setting
	220V:340~380V	360V	
12.02	Energy consumption braking return difference voltage		Model setting
	220V:10~100V	5V	
	380V:10~100V	10V	
12.03	Energy consumption braking action ratio		100%
	10~100%		

The above function codes are used to set the voltage threshold value, return difference voltage value and brake unit utilization rate of the built-in brake unit of the inverter. If the internal DC side voltage of the inverter is higher than the starting voltage of energy consumption braking, the built-in braking unit will act. If a braking resistor is connected at this time, the internal pumping voltage energy of the inverter will be released through the braking resistor to reduce the DC voltage. When the DC side voltage drops to a certain value (starting voltage-brake backlash), the built-in brake unit is turned off.

HV100 Series High Performance Current Vector Inverter

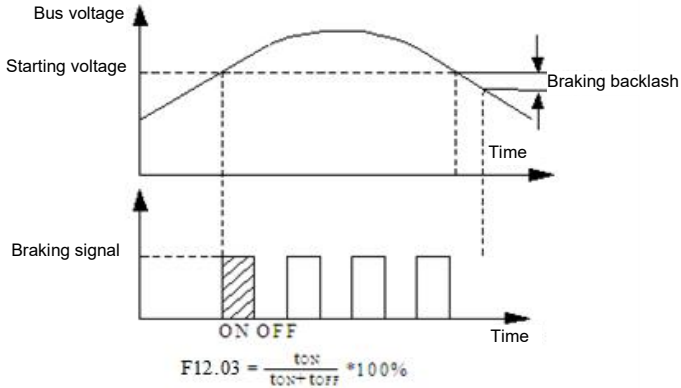

Figure 012-1 Schematic diagram of energy consumption braking

12.04	Power failure restart settings	
	0~2	0

0: Prohibited

When the power is turned on after power failure, the inverter will not run automatically.

1: Starting from starting frequency

When the power is turned on after power failure, if the starting conditions are met, the inverter will automatically start running from the starting frequency point after waiting for the time defined in 12.05.

2: Speed tracking starting

When the power is turned on after a power failure, if the starting conditions are met, the inverter will automatically start and run in speed tracking mode after waiting for the time defined in 12.05.

12.05	Waiting time for restart after power failure	
	0.0~60.0S	5.0

During the waiting time for restart, any operation command entered is invalid. If the shutdown command is input, the inverter will automatically release the speed tracking restart state and return to the normal shutdown state.



Notes:

1: The valid restart after power failure is also related to the setting of 10.02. At this time, 10.02 must be set to 0.

2: This parameter will cause unexpected motor starting, which may cause potential damage to equipment and personnel. Please use it with caution.

12.06	Automatic fault reset times	
	0~100	0
12.07	Automatic fault reset interval time	
	0.1~60.0S	3.0

100: Means unlimited times, that is, countless times

After a fault occurs during operation, the inverter stops outputting and displays the fault code. After the reset interval set in 12.07, the inverter automatically resets the fault and restarts the operation according to the set starting mode.

The number of automatic fault resets is set by 12.06. When the number of fault reset is set to 0, there is no automatic reset function and can only be reset manually. When 12.06 is set to 100, it means that the number of times is unlimited, that is, countless times.

For IPM faults, external equipment faults, etc., the inverter is not allowed to conduct self-reset operation.

12.08	Cooling fan control	
	0~1	0

0: Automatic control mode

1: The power on process runs all the time

HV100 Series High Performance Current Vector Inverter

12.09	Password for running restricted function	
	0~65535	0

By default, the password is 0 ,and 12.10 and 12.11 items can be set; When there is a password, 12.10 and 12.11 can only be set after the password is verified correctly.

When there is no need to operate the limit password function, the function code is set to 0.

When setting the operation limit password, enter five digits, press the **ENTER** key to confirm, and the password will automatically take effect after one minute.

When you need to change the password, select 12.09 function code, press the **ENTER** key to enter the password verification state, enter the modification state after the password verification is successful, enter the new password, press the **ENTER** key to confirm, the password change is successful, and the password will automatically take effect after one minute; Clear the password and set the running limit password to 0000.

12.10	Selection for running restricted function	
	0~1	0

0: Prohibited

1: Valid

When limiting the operation, as long as the cumulative operation time of the inverter exceeds the time set in 12.11, the inverter protection acts and stops freely, and the operation panel will display E-26(RUNLT). If you want to clear the fault, just verify 12.09 (operation restriction password) correctly, and then set 12.10 (operation restriction function selection) to 0 (invalid)to clear the operation restriction fault.

12.11	Run limit time	
	0~65535h	0

Note: This function parameter cannot be initialized. Please refer to 12.09 for details

12.12	Frequency drop point at instantaneous power failure	
	220V:180V~330V 250V	Model setting
	380V:300V~550V 450V	

If the inverter bus voltage drops below 12.12* rated bus voltage, and the instantaneous stop control is valid, the instantaneous stop starts to act.

12.13	Frequency drop coefficient of instantaneous power failure	
	1 ~ 100 0: The instantaneous stop function is invalid	0

12.14	Droop control	
	0.00~10.00HZ	0.00

0.00: The droop control function is invalid

When multiple inverters drive the same load, the load distribution is unbalanced due to different speeds, which makes the inverters with higher speed bear heavier loads. The droop control characteristic is that the speed droop changes with the increase of load, which can make the load distribution balanced; This parameter adjusts the frequency variation of the frequency converter with droop speed.

When 00.15=1 (high frequency mode), the upper limit of the value of this function code is 100.0Hz.

12.15	Speed tracking waiting time	
	0.1~5.0S	1.0

Before the inverter speed tracking starts, it will start tracking after this delay.

12.16	Speed tracking current limiting level	
	80% ~ 200% * rated current of inverter	100%

In the process of speed tracking, this function code plays the role of automatic current limiting. When the actual current reaches the threshold (12.16), the inverter will reduce the frequency and limit the current, and then continue to track and accelerate; The set value is a percentage of the rated current of the inverter.

12.17	Speed tracking speed	
	1~125	25

HV100 Series High Performance Current Vector Inverter

When the speed tracking restarts, select the speed of speed tracking. The smaller the parameter, the faster the tracking speed. But too fast may lead to unreliable tracking.

12.18	PWM mode	
	0000~1311	001

Led bits: PWM synthesis mode

0: Full frequency seven segments

The current output is stable, and the calorific value of the full-band power tube is large.

1: Seven segments to five segments

The current output is stable, the calorific value of low-frequency power tube is large, and the calorific value of high-frequency power tube is small.

LED Ten bits: PWM temperature correlation

0: Invalid

1: Valid

This function selection is valid. If the radiator temperature reaches the warning value (50 °C), the inverter will automatically reduce the carrier frequency until the radiator temperature no longer exceeds the warning value.

LED hundred-bits: PWM frequency correlation

0: All invalid

1: Low frequency adjustment, High frequency adjustment

2: Low frequency doesn't adjust, High frequency adjustment

3: Low frequency adjustment, High frequency doesn't adjust

When the PWM temperature is associated, after the radiator temperature reaches the warning value (50 °C), if the low frequency and high frequency are not adjusted, the carrier frequency remains unchanged; if the low frequency and high frequency are adjusted, the inverter will automatically reduce the carrier frequency.

LED Thousands: Flexible PWM function.

0: Invalid

1: Valid

When this function selection is valid, the electromagnetic interference and motor noise can be reduced by changing the implementation mode of PWM.

12.19	Voltage control function	
	0000~3112	2112

LED bits: AVR function

0: Invalid

1: Valid throughout

2: Invalid only when decelerating

AVR is the automatic voltage regulation function. When there is a deviation between the input voltage and the rated value of the inverter, this function can keep the output voltage of the inverter constant to prevent the motor from operating in an overvoltage state. This function is invalid when the output command voltage is greater than the input power supply voltage. In the deceleration process, if the AVR does not act, the deceleration time is short, but the running current is large; The AVR acts, the motor decelerates smoothly, the running current is small, but the deceleration time is long.

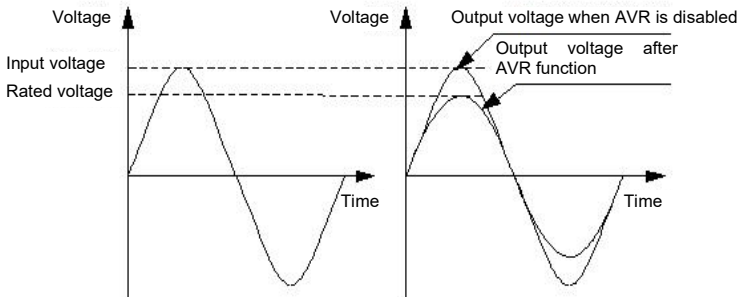

Figure 012-2 Function Diagram of AVR

HV100 Series High Performance Current Vector Inverter

LED ten bits: Over modulation selection

0: Invalid

1: Valid

The over-modulation function means that the inverter increases the output voltage by adjusting the utilization rate of the bus voltage. When the over-modulation is effective, the output harmonics will increase. If long-term low-voltage and heavy-load operation or high-frequency (over 50HZ) operating torque is insufficient, this function can be turned on.

LED hundred bits: dead zone compensation selection

0: Invalid

1: Valid

If the selection is valid, under all control modes, full frequency dead zone compensation. This function is mainly used for factory debugging, and it is not recommended for customers to set it.

LED thousand bits: Vibration suppression options

0: Invalid

1: Oscillation suppression mode 1

2: Oscillation suppression mode 2

3: Oscillation suppression mode 3

When mode 1 works, the PWM mode is forced to be five segment; When mode 2 works, the original mode remains unchanged, and the two modes can be adjusted by the oscillation suppression coefficient (12.27).

In special occasions, if the first two modes cannot suppress the oscillation, use mode 3, and adjust the parameters 12.27 (oscillation suppression coefficient) and 12.28 (oscillation suppression voltage) together.

12.20	Oscillation suppression starting frequency	
	0.00~300.00	Model setting
12.21	Magnetic flux braking selection	
	0~100	0

This parameter is used to adjust the magnetic flux braking ability of the inverter during deceleration. The larger this value is, the stronger the magnetic flux braking ability is. To a certain extent, the shorter the deceleration time, the parameter generally does not need to be set. When this value is 0, this function is invalid.

When the overvoltage limit level is set low, turning on this function can shorten the deceleration time appropriately. When the overvoltage limit level is set high, it is not necessary to turn on this function.

12.22	Energy saving control coefficient	
	0~100	0

The larger the parameter setting, the more significant the energy-saving effect, but it may bring unstable factors. This function is only valid for normal V / F control and is invalid when it is set to 0

12.23	Multi-speed priority enable	
	0~1	0

0: Invalid

1: Multi segment speed takes precedence over 00.07

12.24	JOG priority enable	
	0~1	0

0: Invalid

1: When the inverter is running, the JOG priority is the highest

12.25	Special function	
	0000~001	10

LED bits: AO2 and DO output selection

0: AO2 valid

1: DO is valid

LED Ten bits: IPM fault setting

0: Shield the fault

1: The fault is valid

LED hundred bits: Input phase failure reset selection

0: Unable to reset

HV100 Series High Performance Current Vector Inverter

1: It can be reset after the power supply is normal

LED thousand bits: Reserved

12.26	Upper limit frequency of oscillation suppression	
	0.00~300.00Hz	50.00
12.27	Oscillation suppression coefficient	
	1~500	50
12.28	Oscillation suppression voltage	
	0.0 ~ 25.0% * rated Voltage of motor	5.0

12.27~12.28 Please refer to the description of 12.19 for details.

12.29	Wave-by-wave current limiting and anti-overvoltage action selection	
	0000~1111	011

LED bits: Selection of wave by wave current limiting acceleration

0: Invalid

1: Valid

LED ten bits: Selection of wave by wave current limiting deceleration

0: Invalid

1: Valid

LED hundred-bit: Selection of wave by wave current limiting and constant speed

0: Invalid

1: Valid

LED Thousand bits: Selection of anti overvoltage action

0: Invalid

1: Valid

12.30	Special function selection	
	00~11	00

LED bits: Direct-Start function select

0: Invalid

1: Valid

This function is only valid when running at constant speed.

LED Ten bits: Display selection of over-torque alarm A-05

0: Display

1: Do not display

LED hundred bits: Reserved

LED thousand bits: Reserved

013 Group-Reserved parameters

014 Group-Panel function setting and parameter management

14.00	M-FUNC function selection	
	0~4	0

0: JOG (jog control)

The  key is jog control, and the default direction is determined by 00.18.

1: Forward/Reverse rotation switch

In the running state, the  key is equivalent to the direction switch key, and pressing this key in the shutdown state is invalid. This switch is only valid for the panel run command channel.

2: Clear the panel  key to set the frequency

3: Switching between local operation and remote operation (reserved)

4: Reverse

At this time, the  key can be directly used as the reverse key to control the reverse operation of the motor.

HV100 Series High Performance Current Vector Inverter

14.01	Selection of STOP/RST key function	
	0~3	3

0: Only valid for panel control

Only when 00.04=0, this key can control the inverter to stop.

1: Valid for both panel and terminal control

Only when 00.04=0 or 1, this key can control the inverter to stop. In the communication control operation mode, this key is invalid.

2: Valid for panel and communication control at the same time

Only when 00.04=0 or 2, this key can control the inverter to stop. In terminal control operation mode, this key is invalid.

3: Valid for all control modes

In any operation command channel mode, this key can control the inverter to stop.



Tips:

In any operation command channel mode, the reset function is valid .

14.02	STOP key +RUN key emergency stop function	
	0~1	1

0: Invalid

1: Free stop

Press the key and the key at the same time, and the inverter will stop freely.

14.03	Closed loop display coefficient	
	0.01~100.00	1.00

This function code is used to correct the display error between the actual physical quantity (pressure, flow, etc.) and the given or feedback quantity (voltage, current) during closed-loop control, and has no influence on closed-loop adjustment.

14.04	Load speed display coefficient	
	0.01~100.00	1.00

This function code is used to correct the display error of speed scale, and has no influence on the actual speed.

14.05	Line speed coefficient	
	0.01~100.00	1.00

This function code is used to correct the display error of linear speed scale, and has no influence on the actual speed.

14.06	Encoder adjustment rate	
	1~100	70

14.07	Monitoring parameter selection 1 in running state (main display)	
	0~57	0

14.08	Monitoring parameter selection 2 in running state (Auxiliary display)	
	0~57	5

The monitoring items of the main monitoring interface can be changed by changing the set values of the above function codes. For example, if 14.08=5, that is, the output current d-05 is selected, the default display item of the main monitoring interface is the current output current value during operation.

14.09	Monitoring parameter selection 1 in stop state (main display)	
	0~57	1

14.10	Monitoring parameter selection 2 in stop state (main display)	
	0~57	12

The monitoring items of the main monitoring interface can be changed by changing the set values of the above function codes. For example, if 14.10=6, that is, the output voltage d-06 is selected, the default display item of the main monitoring interface will be the current output voltage value when the machine stops.

HV100 Series High Performance Current Vector Inverter

14.11	Parameter display mode selection	
	00~1011	0100

LED bits: Function parameter display mode selection

0: Display all function parameters

1: Only parameters different from the factory values are displayed

2: Only display the parameters modified after the last power-on (reserved)

LED ten bits: Monitor parameter display mode selection

0: Only the main monitoring parameters are displayed

1: Main and auxiliary display alternately (interval is 1S)

LED hundred bits: Reserved

LED thousand bits: Panel ▲/▼ key adjustment enable

0: Valid

1: Invalid

14.12	Parameter initialization	
	0~3	0

0: No-operation

The inverter is in normal parameter reading and writing status. Whether the function code setting value can be changed is related to the setting status of the user password and the current operating status of the inverter.

1: All user parameters except motor parameters are restored to factory settings

The motor parameters are not restored, and other user parameters are restored to the factory set values according to the model.

2: All user parameters are restored to factory settings

All user parameters are restored to the factory settings according to the model.

3: Clear fault record

Clear the contents of fault records (D-48 ~ D-57).

After the operation is completed, this function code is automatically cleared to 0.

14.13	Parameter protection	
	0~2	0

0: All parameters are allowed to be modified (some parameters cannot be modified during operation)

1: Only the frequency setting parameters 00.09, 00.10 and this function code can be modified

2: All parameters except this function code are forbidden to be modified

14.14	Parameter copy function	
	0~3	0

0: No operation

1: Upload parameters to the panel

After setting it to 1, and confirming, the panel displays CP-1, and the inverter uploads all the function code parameters in the control panel to the EEPROM of the operation panel for storage.

2: All function code parameters are downloaded to the inverter

After setting it to 2 and confirming it, the panel displays CP-2, and the inverter downloads all the function code parameters in the operation panel except the manufacturer parameters to the memory of the main control board, and refreshes the EEPROM.

3: All function code parameters except the motor parameters are downloaded to the inverter

After setting it to 3 and confirming it, the panel displays CP-3, the inverter downloads all the function code parameters in the operation panel to the main control board memory (except the motor parameter group and the manufacturer parameter group), and refreshes the EEPROM.

14.15	Software version	
	1.00~99.99	4.12
14.16	Keypad version	
	1.00~99.99	1.00
14.17	Inverter rated power	
	0.4~999.9KW (G/P)	Model setting

HV100 Series High Performance Current Vector Inverter

The above function codes are used to indicate the relevant information of the inverter, which can only be viewed and cannot be modified.

14.18	Inverter type selection	
	0~1	0

0: G type (constant torque load type)

1: P type (fan, water pump load type)

In this inverter, the G/P model is combined, that is, the G model with a lower power can be used as a P model with a higher power. But the premise is that this function code must be set to the corresponding value.

015 Group - Multi-pump water supply parameters

15.00	Terminal delay time	
	0.0~600.0s	0.1

The delay time when the pump is switched on and off.

15.01	Polling time	
	0.0~600.0h	48

Polling time is the time to switch the variable frequency pump regularly, which is only valid when a single pump is operating.

15.02	Lower limit frequency of reducing the number of pump	
	0.0~600.00HZ	35.00

When the feedback pressure is higher than the set pressure and the frequency drops to the lower limit frequency of pump reduction, the pump is reduced after the delay time of pump reduction.

15.03	Main pump start delay time	
	0.0~3600.0S	0.3

This parameter is used in "one drive three constant pressure water supply", after the main and auxiliary pumps are switched, the main pump will start delay.

15.04	Auxiliary pump Start-up mode	
	0~1	0

0: Direct start

This method is mainly used for water pumps below 7.5KW. When the pressure is not enough, it can be started directly at power frequency.

1: Soft start

This method is mainly used to start the two pumps at low frequency when one is driven by two.

15.05	Add pump delay time	
	0.0~3600.0S	10.0

15.06	Reduce pump delay time	
	0.0~3600.0S	10.0

15.07	Sensor range	
	0.000~60.000MPa	10.000

15.08	Pressure setting (MPa)	
	0.000~ 【08.25】	5.000

If P08.01=5, select the sensor range (15.07) and given pressure (15.08) according to the field conditions.

HV100 Series High Performance Current Vector Inverter

016 Group- Photovoltaic water pump parameters

16.00	Lack of water detect time	
	0~250s	10
16.01	MPPT low point operating voltage	
	0~MPPT High point operating voltage	350/200V
16.02	MPPT high point operating voltage	
	【16.01】~1000/ 【16.01】~500	537/311V
16.03	Photovoltaic pump water shortage detection current corresponds to the ratio of no-load current	
	80.0~300.0%*No load current of motor	150.0
16.04	Minimum operating frequency of photovoltaic pump effluent	
	0.00Hz~ ~ upper limit frequency	20.00

If the bus voltage (d-12) is higher than the set value of MPPT high working voltage (16.02), run at the maximum frequency; If it is lower than the set value of MPPT high-point working voltage (16.01), it will run at the frequency obtained by (bus voltage /MPPT high-point working voltage) * maximum frequency; if the bus voltage reaches MPPT low-point working voltage (16.01), it will run at the lowest running frequency (16.04); if the inverter runs above the lowest running frequency, and the output current is less than the no-load current of motor * water shortage detection current of photovoltaic pump.

Chapter VIII EMC (Electromagnetic Compatibility)

8.1 Definitions

Electromagnetic compatibility (EMC) refers to the ability of electrical equipment to operate in an electromagnetic interference environment without interfering with the electromagnetic environment and to stably realize its functions.

8.2 Introduction to EMC Standards

According to the requirements of national standard GB/T12668.3, the inverter needs to meet the requirements of electromagnetic interference and anti-electromagnetic interference.

Our existing products comply with the latest international standard: IEC/EN61800-3: 2004 (adjustable speed electrical power drive systems part 3: EMC requirements and specific test methods), which is equivalent to the national standard GB/T12668.3.

IEC/EN61800-3 mainly investigates inverters from two aspects: electromagnetic interference and anti-electromagnetic interference. Electromagnetic interference mainly tests radiation interference, conduction interference and harmonic interference of inverters (this requirement is applicable to inverters used for civil use). Anti-electromagnetic interference mainly affects the transmission immunity, radiation immunity, surge immunity, fast burst immunity, ESD immunity and power supply low-frequency end immunity (specific test items include:

1. Immunity test of input voltage sag, interruption and change;
2. Commutation notch immunity test;
3. Harmonic input immunity test;
4. Input frequency change test;
5. Input voltage imbalance test;
6. Input voltage fluctuation test).

According to the strict requirements of IEC/EN61800-3, our products are installed and used according to the instructions shown in 7.3, and will have good electromagnetic compatibility in general industrial environment.

8.3 EMC guidance

8.3.1 Influence of harmonics:

High-order harmonics of power supply will damage the inverter. Therefore, it is suggested to install AC input reactors in some places with poor power grid quality.

8.3.2 Electromagnetic interference and installation precautions:

There are two kinds of electromagnetic interference, one is the interference of the electromagnetic noise of the surrounding environment to the inverter, and the other is the interference of the inverter to the surrounding equipment.

Precautions for installation:

- 1) the grounding wires of inverters and other electrical products shall be well grounded;
- 2) The power input and output lines and weak current signal lines (such as control lines) of the inverter should not be arranged in parallel as far as possible, but should be arranged vertically when there are pieces;
- 3) It is recommended to use shielded cable or steel pipe to shield the power line for the output power line of the inverter, and the shielding layer should be reliably grounded. For the lead of the interfered equipment, it is recommended to use twisted shielded control line and reliably ground the shielding layer;
- 4) If the length of motor cable exceeds 100m, it is required to install output filter or reactor.

8.3.3 Treatment method of interference of peripheral electromagnetic equipment to inverter:

Generally, the electromagnetic influence on the inverter is caused by a large number of relays, contactors or electromagnetic brakes installed near the inverter. When the inverter malfunctions due to interference, the following measures are recommended:

- 1) Surge suppressors are installed on devices that generate interference;
- 2) Install a filter at the input end of the inverter, refer to 7.3.6 for specific operation;
- 3) The leads of control signal lines and detection lines of inverters shall be shielded cables and the shielding layer shall be grounded reliably.

8.3.4 Measures to deal with interference caused by inverter to peripheral equipment:

There are two kinds of noise in this part: one is the radiation interference of inverter, and the other is the conduction interference of inverter. These two kinds of interference make peripheral electrical equipment suffer electromagnetic or

HV100 Series High Performance Current Vector Inverter

electrostatic induction. Thereby causing misoperation of the equipment. According to several different interference situations, refer to the following methods to solve them:

1) The instruments, receivers and sensors used for measurement have weak signals. If they are close to the inverter or in the same control cabinet, they are prone to interference and misoperation. The following solutions are recommended: try to stay away from interference sources; Do not arrange the signal line and the power line in parallel, especially do not bundle them together in parallel; Shielding wires shall be used for signal lines and power lines, and the grounding shall be good; Add ferrite magnetic ring on the output side of the inverter (choose the suppression frequency in the range of 30 ~ 1000 MHz) and wind it for 2 ~ 3 turns in the same direction. For the bad situation, you can choose to install EMC output filter;

2) When the interfered equipment and the inverter use the same power supply, it will cause conducted interference. If the interference cannot be eliminated by the above methods, an EMC filter should be installed between the inverter and the power supply (refer to 7.3.6 for selection operation);

3) The peripheral equipment is grounded separately, which can eliminate the interference caused by leakage current in the grounding line of the inverter.

8.3.5 Leakage current and treatment:

There are two forms of leakage current when using inverter: one is leakage current to ground; The other is the leakage current between lines.

1) factors affecting the floor drain current and solutions:

There is distributed capacitance between the conductor and the ground, and the greater the distributed capacitance, the greater the leakage current; Effectively reduce the distance between inverter and motor to reduce distributed capacitance. The larger the carrier frequency, the greater the leakage current. The carrier frequency can be lowered to reduce leakage current. However, reducing the carrier frequency will lead to an increase in motor noise. Please note that installing reactors is also an effective way to solve leakage current.

The leakage current will increase with the increase of loop current, so when the motor power is high, the corresponding leakage current will be large.

2) Factors causing leakage current between lines and solutions:

There is distributed capacitance between the output wires of the inverter. If the current passing through the wires contains higher harmonics, it may cause resonance and leakage current. At this time, if the thermal relay is used, it may cause misoperation.

The solution is to reduce the carrier frequency or install an output reactor. When using the inverter, it is suggested that no thermal relay should be installed between the inverter and the motor, and the electronic overcurrent protection function of the inverter should be used.

8.3.6 Precautions for installing EMC input filter at power input end:

1) ⚠️ Note: Please use the filter strictly according to the rated value; As the filter belongs of Class I electrical appliances; the metal outer shell for the filter should have good contact with the metal for the installation cabinet of large area; and it is required of have good conductivity continuity; otherwise; there will be the danger for electrical contact and seriously affect the EMC effect.

2) Through EMC test, it is found that the filter ground must be connected to the same common ground as the PE end of the inverter, otherwise the EMC effect will be seriously affected.

3) Install the filter as close as possible to the power input of the inverter.

Chapter IX Fault Diagnosis and Countermeasures

9.1 Fault Alarm and Countermeasures

In case of abnormality during operation, the inverter immediately blocks the PWM output and enters the fault protection state. At the same time, the current fault information is indicated by the flashing fault code on the keyboard. At the same time, the fault indicator ALM lights up. At this time, it is necessary to check the cause of the fault and the corresponding treatment method according to the method suggested in this section. If the problem still cannot be solved, please contact our company directly. Please refer to Table 9-1 Fault Diagnosis and Elimination for corresponding solutions.

Fault code	Name	Possible reason of fault	Fault countermeasures
E-01	Overcurrent during acceleration	Acceleration time is too short (including tuning process)	Extended the acceleration time
		Restart the rotating motor	Set to start after DC braking or speed tracking start
		Low inverter power	Choose a inverter with high power level
		Improper setting of V/F curve or torque boost	Adjust V/F curve or torque lift
E-02	Overcurrent during deceleration	Deceleration time is too short (including tuning process)	Extended deceleration time
		Low inverter power	Choose a inverter with high power level
		Excessive load inertia	External braking resistor or braking unit
E-03	Overcurrent in constant speed	Low grid voltage	Check the input power supply
		The load is mutated or abnormal	Check the load or reduce the load mutation
		Low inverter power	Choose a inverter with high power level
E-04	Overvoltage during acceleration	Abnormal input voltage (including tuning process)	Check the input power supply
		Restart the rotating motor	Set to start after DC braking or speed tracking start
		Special potential energy load	External braking resistor or braking unit
E-05	Overvoltage during deceleration	Deceleration time is too short (including tuning process)	Extended deceleration time
		Excessive load inertia	External braking resistor or braking unit
		Input voltage abnormal	Check the input power supply
E-06	Overvoltage in constant speed	Input voltage abnormal	Check the input power supply
		Special potential energy load	External braking resistor or braking unit
E-07	DC Bus undervoltage	Input voltage is abnormal or contactor (relay) is not pulled in	Check the power supply voltage or ask the manufacturer for service
E-08	Motor overload	Improper setting of V/F curve or torque boost	Adjust V/F curve or torque lift
		Grid voltage is too low	Check the grid voltage
		The motor is locked or the load mutation is too large	Check the load
		Motor overload protection factor is not set correctly	correctly set Motor overload protection coefficient
E-09	Inverter overload	Improper setting of V/F curve or torque boost	Adjust V/F curve or torque lift
		Grid voltage is too low	Check the grid voltage
		Acceleration time is too short	Extended the acceleration time
		The motor is overloaded	Choose a inverter with higher power
E-10	Inverter drop load	Output current is less than load drop detection value	Check the load
E-11	Power module failure	Inverter output short circuit or grounding	Check the motor wiring
		Instantaneous overcurrent of inverter	See overcurrent countermeasures
		Blocked air duct or damaged fan	Clear the air duct or replace the fan
		Abnormal control keypad or serious interference	Seek services from manufacturers

HV100 Series High Performance Current Vector Inverter

Fault code	Name	Possible reason of fault	Fault countermeasures
		Power device damage	Seek services from manufacturers
E-12	Phase loss on the input side	Current Abnormality	Check the power supply and connection
E-13	Phase loss or current imbalance on the output side	Output U, V and W are out of phase	Check the output wiring
E-14	Output short circuit to ground	Reservation	Reservation
E-15	Radiator overheated1	Ambient temperature is too high	Lower ambient temperatures
E-16	Radiator overheated2	Fan damaged	Replace the fan
		Clogged air duct	Clear the air duct
E-17	RS485 communication failure	Does not match the baud rate of the upper computer	Adjust baud rate
		RS485 channel interference	Check whether the communication connection is shielded and the wiring is reasonable. If necessary, consider connecting the filter capacitor in parallel
		Communication timeout	Retry
E-18	Keyboard communication failure	The connection line between keyboard and control board is damaged	Replace the connecting cable between keyboard and control board
E-19	External equipment fault	External equipment fault input terminal closed	Disconnect the fault input terminal of external equipment and clear the fault (pay attention to check the cause)
E-20	Current detection error	Malfunction of hall element or amplifier circuit	Seek services from manufacturers
		Auxiliary power failure	
		Hall or power board wiring is in poor contact	
E-21	Motor tuning fault	Incorrect setting of motor parameters	Reset the motor parameters
		The power specification of inverter and motor is serious mismatch	Seek services from manufacturers
		Tuning timeout	Check the motor connection
E-22	EEPROM read-write failure	EEPROM fault	Seek services from manufacturers
E-23	Error in copying parameters	Data error when inverter parameters are uploaded to keypad	Check the wire connection of the keypad
		Data error when parameters are downloaded from the keypad to the inverter	Check the wire connection of the keypad
		Download parameters directly without copying and uploading parameters	Upload the parameters first, then download them
E-24	PID feedback disconnection	Loose PID feedback circuit	Check the feedback connection
		The feedback amount is less than the disconnection detection value	Adjust the detection input threshold
E-25	Voltage feedback disconnection	The feedback amount is less than the disconnection detection value	Adjust the detection input threshold
E-26	Running limit time Arrival	Run limit time reached	Seek services from agents
E-27	EEPROM detection fault	EEPROM detection fault	Seek services from manufacturers
E-32	Water shortage detection fault	Water shortage detection fault of photovoltaic pump	See description of 16.00 ~ 16.04 for details.
E-34	Bus undervoltage automatic reset fault	DC bus voltage is too low	See description of 05.25 ~ 05.26 for details.

HV100 Series High Performance Current Vector Inverter

9.2 Exception handling

See table 9-2 for the common abnormal phenomena and countermeasures of inverter in operation:

Abnormal phenomena		Possible causes and countermeasures
The motor does not rotate	Keyboard does not display	Check whether there is a power outage, whether the input power supply is out of phase, and whether the input power cord is connected incorrectly
	The keyboard is not displayed, but the internal charging indicator is on	Check whether there are problems with the wiring and sockets related to the keyboard, and measure the voltage of each control power supply in order to confirm whether the switching power supply works normally. If the switching power supply does not work normally, check whether the inlet (+,-) sockets of the switching power supply are connected well, whether the starting vibration is damaged or whether the voltage stabilizing tube is normal.
	The motor is buzzing	The motor load is too heavy, try to reduce the load
	No abnormalities were found	Check whether it is in tripping state or not reset after tripping, whether it is in power-off restart state, whether the keyboard has been reset, whether it has entered program running state, multi-speed running state, specific running state or non-running state, and try to restore the factory value.
Confirm whether the operation instruction is given		
Check whether the operating frequency is set to 0		
The motor cannot accelerate and decelerate smoothly	Inappropriate setting of acceleration and deceleration time, increase acceleration and deceleration time	
	If the current limiting value is set too small, increase the limiting value	
	Over-voltage protection acts during deceleration to increase deceleration time	
	Improper setting of carrier frequency, overload or oscillation	
	Overload and insufficient torque. Increase the torque boost value in V/F mode. If it still cant meet the requirements, you can switch to automatic torque boost mode. At this time, pay attention to the fact that the motor parameters should be consistent with the actual values. If it still cant meet the requirements, it is recommended to switch to advanced V/F control mode. At this time, you should still pay attention to whether the motor parameters are consistent with the actual values, and it is best to tune the motor parameters.	
	The motor power does not match the inverter power. Please set the motor parameters to actual values	
	One with more than one motor. Please change the torque lifting mode to manual lifting mode	
Although the motor can rotate, it can not adjust the speed	Inappropriate setting of upper and lower frequency limits	
	The frequency setting is too low, or the frequency gain setting is too small	
	Check whether the speed regulation mode used is consistent with the set frequency	
	Check whether the load is too heavy, over-voltage stall or over-current limit	
The speed of the motor changes during operation	Load fluctuates frequently, so minimize its variation	
	Inverter is seriously inconsistent with motor rating. Please set the motor parameters to actual values	
	Poor contact of frequency setting potentiometer or fluctuation of frequency given signal. Change to digital frequency giving mode or increase the filtering time constant of analog input signal	
The rotation direction of the motor is opposite	Adjust the phase sequence of output terminals u, v and W.	
	Set the running direction (00.18=1) to reverse	
	Direction uncertainty caused by output phase failure, please check the motor wiring immediately	

Appendix 1: Modbus communication protocol

1. RTU mode and format

When the controller communicates on Modbus bus in RTU mode, every 8-bit byte in the information is divided into 2 4-bit hexadecimal characters, which

The main advantage of mode is that the density of characters transmitted by mode is higher than that of ASCII mode at the same baud rate, and every message must be continuously transmitted.

(1) the format of each byte in 1)RTU mode

Coding system: 8-bit binary, hexadecimal 0-9, A-F.

Data bit: 1-bit start bit, 8-bit data (lower bit first sent), 1-bit stop bit, and optional parity bit. (Refer to RTU data frame as sequence diagram)

Error check area: cyclic redundancy check (CRC).

(2)RTU data frame bit sequence diagram

With parity check

Start	1	2	3	4	5	6	7	8	Far	Stop
-------	---	---	---	---	---	---	---	---	-----	------

No parity check

Start	1	2	3	4	5	6	7	8	Stop
-------	---	---	---	---	---	---	---	---	------

2. Registers address and function code of series inverter

(1) Supported function codes

Function code	Functional Description
03	Read multiple registers
06	Write a single register
10	Write multiple registers continuously
13	Read a single parameter

(2) Register address

(2) Register Map	Address
Control command input	0DI2000
Monitoring parameter reading	0xD000 (0DI1D00) ~0xD039 (0DI1D39)
MODBUS frequency setting	0DI201
MODBUS torque setting	0DI2002
MODBUS PID frequency given	0DI2003
MODBUS PID feedback setting	0DI2004
MODBUS analog output AO1 control	0di2005 (0 ~ 7fff means 0% ~ 100%)
MODBUS analog output AO1 control	0DI2006 (0 ~ 7FFF means 0% ~ 100%)
MODBUS pulse DO output control	0DI2007 (0 ~ 7FFF means 0% ~ 100%)
MODBUS digital output terminal control	0DI2008
Parameter setting	0x0000 ~ 0xF016

(3) Read multiple parameters in 3)03H (read 8 items continuously at most)

Inquiry information frame format:

Address	01H
Function	03H
Starting data address	00H
	01H
Number of Data(Byte)	00H
	02H
CRC CHK High	95H
CRC CHK Low	CBH

HV100 Series High Performance Current Vector Inverter

Analysis of this data:

01H is the inverter address
 03H is the read function code
 001H is item 00.01 of the starting address similar to the control keypad.
 0002H is the number of items in the reading menu, and two items are 00.01 and 00.02
 95CBH is a 16-bit CRC check code

The Response information frame format (return frame)

Address	01H
Function	03H
DataNum*2	04H
Data1[2Byte]	00H
	00H
Data2[2Byte]	00H
	01H
CRC CHK High	3BH
CRC CHK Low	F3H

Analysis of this data:

01H is the inverter address
 03H is the read function code
 04H is the product of reading item *2
 0000H reads the data of item 00.01
 001H reads the data of item 00.02
 3BF3H is a 16-bit CRC check code

Example:

Name	Frame lattice
Read the data of 00.01 and 00.02	Send frame: 01H 03H 001H 0002H 95CBH
	Return frame: 01H03H04H00000H01H3BF3H
Read the data of item 02.01	Send frame: 01H 03H 0201H 001H D472H
	Return frame: 01H 03H 02H 000FH F840H
Read the monitoring parameters of item d-00 (the address D000H and 1D00H are common)	Send frame: 01H 03H D000H 001H BCCA4H
	Return frame: 01H 03H 02H 1388H B512H
	Send frame: 01H 03H 1D00H 001H 8266H Return frame: 01H 03H 02H 1388H B512H
Read the status of inverter during shutdown (the address A000H is common with 1A00H, refer to the description of inverter running status later)	Send frame: 01H 03H A000H 001H A60AH
	Return frame: 01H 03H 02H 0040H B9B4H
	Send frame: 01H 03H 1A00H 001H 8312H Return frame: 01H 03H 02H 0040H B9B4H
Read the fault code E-19 (the address E000H and 1E00H are common, refer to the following inverter fault code table)	Send frame: 01H 03H E000H 001H B3CAH
	Return frame: 01H 03H 02H 013H F989H
	Send frame: 01H 03H 1E00H 001H 8222H Return frame: 01H 03H 02H 013H F989H
Read the warning code A-18 (the address E01H is common with 1E01, refer to the warning code table of the inverter behind)	Send frame: 01H 03H E01H 001H E20AH
	Return frame: 01H 03H 02H 012H 3849H
	Send frame: 01H 03H 1E01H 001H D3E2H Return frame: 01H 03H 02H 012H 3849H

(4) Write a single parameter in 4)06H
Inquiry information frame format:

Address	01H
Function	06H

HV100 Series High Performance Current Vector Inverter

Starting data address	20H
	00H
Data(2Byte)	00H
	01H
CRC CHK Low	43H
CRC CHK High	CAH

Analysis of this data:

- 01H is the inverter address
- 06H is the write function code
- 2000H is the control command address
- 001H is the forward command
- 43CAH is a 16-bit CRC validation code

The Response information frame format (return frame)

Address	01H
Function	06H
Starting data address	20H
	00H
Number of Data(Byte)	00H
	01H
CRC CHK High	43H
CRC CHK Low	CAH

Analysis of this data: If the settings are correct, return the same input data

Example:

Name	Frame lattice
Forward	Send frame: 01H 06H 2000H 001H 43CAH
	Return frame: 01H 06H 2000H 001H 43CAH
Reverse rotation	Send frame: 01H 06H 2000H 0009H 420CH
	Return frame: 01H 06H 2000H 0009H 420CH
Shutdown	Send frame: 01H 06H 2000H 0003H C20BH
	Return frame: 01H 06H 2000H 0003H C20BH
free stop	Send frame: 01H 06H 2000H 0004H 83C9H
	Return frame: 01H 06H 2000H 0004H 83C9H
Reset	Send frame: 01H 06H 2000H 010H 43CAH
	Return frame: 01H 06H 2000H 010H 43CAH
Forward JOG	Send frame: 01H 06H 2000H 0002H 03CBH
	Return frame: 01H 06H 2000H 0002H 03CBH
Reverse JOG	Send frame: 01H 06H 2000H 000AH 020DH
	Return frame: 01H 06H 2000H 000AH 020DH
Set the parameter of item 08.00 to 1	Send frame: 01H 06H 0800H 001H 4A6AH
	Return frame: 01H 06H 0800H 001H 4A6AH
MODBUS the given frequency is 40HZ	Send frame: 01H 06H 201H 0FA0H D642H
	Return frame: 01H 06H 201H 0FA0H D642H
The MODBUS PID given value is 5V	Send frame: 01H 06H 2003H 01F4H 721DH
	Return frame: 01H 06H 2003H 01F4H 721DH
The feedback value of MODBUS PID is 4V	Send frame: 01H 06H 2004H 0190H C237H
	Return frame: 01H 06H 2004H 0190H C237H
MODBUS the torque is set as 80:	Send frame: 01H 06H 2002H 0320H 22E2H
	Return frame: 01H 06H 2002H 0320H 22E2H

HV100 Series High Performance Current Vector Inverter

Validate user password (address AD00H and 1C00H are common)	Send frame: 01H 06H AD00H 001H 68A6H
	Return frame: 01H 06H AD00H 001H 68A6H
	Send frame: 01H 06H 1C00H 001H 4F9AH
	Return frame: 01H 06H 1C00H 001H 4F9AH
Verification operation restriction function password (address AD01H and 1C01H are common)	Send frame: 01H 06H AD01H 0002H 7967H
	Return frame: 01H 06H AD01H 0002H 7967H
	Send frame: 01H 06H 1C01H 0002H 5E5BH
	Return frame: 01H 06H 1C01H 0002H 5E5BH
MODBUS analog output AO1 controls output 5V	Send frame: 01H 06H 2005H 3FFFFH C3BBH
	Return frame: 01H 06H 2005H 3FFFFH C3BBH
MODBUS analog output AO1 controls output 10V	Send frame: 01H 06H 2006H 7FFFFH 027BH
	Return frame: 01H 06H 2006H 7FFFFH 027BH
MODBUS pulse DO output control output 25KHz	Send frame: 01H 06H 2007H 3FFFFH 627BH
	Return frame: 01H 06H 2007H 3FFFFH 627BH
MODBUS digital output terminal Y1 controls the output	Send frame: 01H 06H 2008H 001H C208H
	Return frame: 01H 06H 2008H 001H C208H

(5) Write multiple parameters continuously

Inquiry information frame format:

Address	01H
Function	10H
Starting data address	01H
	00H
Number of Data(Byte)	00H
	02H
DataNum*2	04H
Data1(2Byte)	00H
	01H
Data2(2Byte)	00H
	02H
CRC CHK High	2EH
CRC CHK Low	3EH

Analysis of this data:

- 01H is the inverter address
- 10H is the write function code
- 0100H is item 01.00 of the starting address similar to the control keypad.
- 0002H is the number of registers
- 04H is the total number of bytes (number of 2* registers)
- 001H is the data of 01.00 items
- 0002H is the data of 01.01 items
- 2E3EH is a 16-bit CRC validation code

The Response information frame format (return frame)

Address	01H
Function	10H
Starting data address	01H
	00H
Number of Data(Byte)	00H

HV100 Series High Performance Current Vector Inverter

	02H
CRC CHK High	40H
CRC CHK Low	34H

Analysis of this data:

01H is the inverter address
 10H is the write function code
 0100H is the data of write 01.00 items
 0002H is the number of items written in the menu, and 01.00 and 01.01
 4034H is a 16-bit CRC check code

Example:

Name	Frame lattice
Set the parameters of 01.00 and 01.01 to 1 and 0.02.	Send frame: 01H 10H 0100H 0002H 04H 001H 0002H 2E3EH
	Return frame: 01H 10H 0100H 0002H 4034H
The given frequency of forward rotation and communication is 50Hz	Send frame: 01H 10H 2000H 0002H 04H 001H 1388H 36F8H
	Return frame: 01H 10H 2000H 0002H 4A08H
Set the parameter of item 01.00 to 1	Send frame: 01H 10H 0100H 001H 02H 001H 7750H
	Return frame: 01H 10H 0100H 001H 0035H

(6) Read a single parameter (including attribute, minimum value and maximum value) in 6)13H

Inquiry information frame format:

Address	01H
Function	13H
Starting data address	00H
	0CH
Number of Data(Byte)	00H
	04H
CRC CHK High	45H
CRC CHK Low	CBH

Analysis of this data:

01H is the inverter address
 13H is the read function code
 000CH is item 00.12 of the starting address similar to the control keypad.
 0004H is the number of registers
 45CBH is a 16-bit CRC validation code

Inquiry information frame format (return frame) :

Address	01H
Function	13H
Starting data address	08H
Data1(2Byte)	13H
	88H
Data2(2Byte)	03H
	22H
Data3(2Byte)	00H
	00H
Data4(2Byte)	13H
	88H
CRC CHK High	28H
CRC CHK Low	31H

Analysis of this data:

HV100 Series High Performance Current Vector Inverter

01H is the inverter address
 13H is the write function code
 08H is the total number of bytes (number of 2* registers)
 1388H is the parameter value
 0322H is the attribute value
 0000H is the minimum value
 1388H is the maximum value
 2831H is a 16-bit CRC check code

Example:

Name	Frame lattice
Read the parameter value of item 00.12	Send frame: 01H 13H 000CH 001H 85CAH
	Return frame: 01H 13H 02H 1388H B1D2H
Read the parameter value of item 00.12 + the attribute value	Send frame: 01H 13H 000CH 0002H C5CBH
	Return frame: 01H 13H 04H 1388H 0322H FC00H
Read the parameter value+attribute value+minimum value of item 00.13	Send frame: 01H 13H 000CH 0003H 040BH
	Return frame: 01H 13H 06H 1388H 0322H 0000H 628BH
Read the parameter value+attribute value+minimum value+maximum value of item 00.13	Send frame: 01H 13H 000CH 0004H 45CBH
	Return frame: 01H 13H 08H 1388H 0322H 0000H 1388H 2831H

3. Description of other register address functions:

Functional Description	address definition	Explanation of data meaning		
		bytes	bit	Meaning
Inverter running state	A000H(1A00H)	Byte1	Bit7	0: no-operation 1: Overload warning
			Bit6~Bit5	0:INV_220V 1:INV_380V 2:INV_660V 3:INV_1140V
			Bit4	0: no-operation 1: power-down storage
			Bit3	0:no-operation 1:Reset
			Bit2~Bit1	0: no-operation 1. Static tuning 2. Dynamic tuning
			Bit0	0: the keypad runs the command channel 1: terminal operation command channel 2: Communication operation command channel 3: Reservation
Inverter running state	A000H(1A00H)	Byte0	Bit7	0: no-operation 1: the bus voltage is normal
			Bit6	0: no-operation 1. Undervoltage
			Bit5	0: no-operation 1: JOG
			Bit4	0: forward 1: reverse

HV100 Series High Performance Current Vector Inverter

			Bit2~Bit1	1: Accelerate operation 2. Decelerating operation 3. Running at a constant speed
			Bit0	0: shutdown status 1: Running status
Read the inverter fault code	E000H(1E00H)	Address E000H and 1E00H are common (see fault code table and example of reading function code 03H).		
Read the inverter fault alarm code	E01H(1E01H)	Address E01H and 1E01H are common (see the list of warning codes and the example of reading function code 03H)		
User password validation	AD00H(1C00H)	Addresses AD00H and 1C00H are common (see the example of writing function code 06H)		
Run limit password validation	AD01H(1C01H)	Addresses AD00H and 1C00H are common (see the example of writing function code 06H)		

4. inverter fault code table:

Fault code	Keyboard display content	Fault information
0000H	—	No Fault
001H	E-01	Accelerating running in operation
0002H	E-02	Overcurrent in deceleration operation
0003H	E-03	Overcurrent in constant speed operation
0004H	E-04	Overvoltage during acceleration in the operation
0005H	E-05	Overvoltage during deceleration in the operation
0006H	E-06	Overvoltage during Constant speed in the operation
0007H	E-07	DC Bus undervoltage
0008H	E-08	Motor overload
0009H	E-09	Inverter overload
000AH	E-10	Inverter off is loaded
000BH	E-11	Power module failure
000CH	E-12	Input side open phase
000DH	E-13	Output side is out of phase or unbalanced in current
000EH	E-14	Output short circuit fault to ground
000FH	E-15	Overheating radiator 1
010H	E-16	Overheating radiator 2
011H	E-17	RS485 communication failure
012H	E-18	Keyboard communication failure
013H	E-19	External equipment fault
014H	E-20	Current detection error
015H	E-21	Motor tuning fault
016H	E-22	EEPROM read-write failure
017H	E-23	Error in copying parameters
018H	E-24	PID feedback disconnection
019H	E-25	Voltage feedback disconnection
01AH	E-26	Run limit time reached
01BH	E-27	EEPROM detection fault
0020H	E-32	Water shortage detection fault
0022H	E-34	Bus undervoltage automatic reset fault

HV100 Series High Performance Current Vector Inverter

5. inverter warning code table:

Alarm code	Keyboard display content	Fault information
0000H	—	No Fault
0005H	A-05	Torque arrival alarm
0009H	A-09	Inverter overload alarm
011H	A-17	RS485 communication failure alarm
012H	A-18	Keyboard communication failure alarm
015H	A-21	Motor tuning fault alarm
016H	A-22	EEPROM read-write failure alarm
018H	A-24	PID feedback disconnection alarm

6. Control command word format (see the example of writing function code 06H):

Address	bit	Meaning
2000H	Bit7~Bit5	Reservation
	Bit4	0: no-operation 1: Reset
	Bit3	0: forward 1: reverse
	Bit2~Bit0	100: free stop 011: shutdown 01: JOG Operation 01: Operation
2008H (press position 1 as output, press position 0 as close)	Bit7~Bit4	Reservation
	Bit3	Output of programmable relay R1
	Bit2	Output of programmable relay R1
	Bit1	Open collector output terminal Y2
	Bit0	Open collector output terminal Y1

7. Parameter attribute table:

bit	Meaning		
Bit15	Reservation		
Bit14	Menu		
Bit13	system		
Bit12	Restore factory value coverage		
Bit11	EEPROM		
Bit10~Bit9	"○":01 "×":10 "◆":11 "◇":00		
Bit8	Symbol		
Bit7~Bit3	1:0000 V:0001 A:0010 rpm:0011 HZ:0100 %:0110 S:01000	KHZ:01100 KW:01010 om:01110 ms:0101 MA:01011 KM:01101 CM:01111	us:1001 HZ/S:10000 mh:1010 C:1011 m/s:10100 H:10101 KWH:10110
Bit2~Bit0	Decimal point		

8. Error code meaning of slave response abnormal information:

Error Code	Description
01H	Illegal function code
02H	Illegal address
03H	Illegal data
04H	Illegal register length
05H	Error in CRC check
06H	Parameters cannot be modified during operation
07H	Parameters cannot be modified
08H	Invalid upper PC control command
09H	Parameters are password protected
0AH	Password error

9. Correspondence addresses corresponding to all parameters of series inverters:

Function code	Communication address
00.00~00.20	6000H~6014H
01.00~01.36	6100H~6124H
02.00~02.17	6200H~6211H
03.00~03.08	6300H~6308H
04.00~04.27	6400H~641BH
05.00~05.24	6500H~6518H
06.00~06.52	6600H~6634H
07.00~07.40	6700H~6728H
08.00~08.24	6800H~6818H
09.00~09.73	6900H~6949H
10.00~10.35	6A00H~6A23H
11.00~11.08	6B00H~6B08H
12.00~12.30	6C00H~6C1EH
14.00~14.18	6E00H~6E12H
15.00~15.08	6000H~6008H
16.00~16.04	7000H~7004H
FFF.00~FFF.22	7100H~7116H
d-00~d-57	D000H (1D00H) ~D039H (1D39H)

Notes:

- In the above examples, the address of the inverter is selected as 01 for convenience of explanation. When the inverter is a slave, the address is set in the range of 1 ~ 247. If any data in the frame format is changed, the check code should be recalculated. You can download the CRC16-bit check code calculation tool online.
- The starting address of the monitored items is D000, and each item is offset by the corresponding hexadecimal value based on this address, and then added to the starting address. For example, the monitoring start item is **D-00**, and the corresponding start address is D000H (**1D00H**). Now read the monitoring item D-18, 18-00 = 18, **and** if **18** is converted into hexadecimal for 12H, then the reading address of D-18 is D000h+12h = D012h (**1D01H**
- The frame format when the slave response information is abnormal: inverter address+(80H+ function code)+error code+16-bit CRC check code; If the frame returned by the slave is 01H+83H+04H+40F3H; ; 01H is the slave address, 83H is 80H+03H, indicating read error, 04H indicates illegal data length, and 40F3H is a 16-bit CRC check code.

Appendix 2: Description of macro parameter setting

Functional macro definition	Setting parameters	Automatically modify parameter list	Commissioning steps
Single pump constant pressure water supply mode	00.01=1	00.04=8; 08.01=5; 14.07=42; 14.08=40; 14.09=42; 14.10=40.	Step1: Initialization of parameter settings (14.12=2) ; Step2: Function macro selection (00.01 = 1); Step3: Set the sensor range (15.07); Step4: Determine the feedback type of the sensor, and input the voltage feedback signal by default for AI1 and AI2, or select the input current feedback signal for AI1 through the jumper seat JP3; Step5: Set the target pressure, which can be set by parameter 15.08 or by keyboard up and down keys.
One inverter with two working (1 variable frequency pump +2 power frequency pumps) water supply mode	00.01=2	00.03=1; 00.04=8; 08.01=5; 14.07=42; 14.08=40; 14.09=42; 14.10=40; 07.00=58; 07.01=59; 07.02=60; 07.03=61; 07.04=62; 07.05=63; 07.18=59; 07.19=60; 07.20=61.	Step1: Initialization of parameter settings (14.12=2) ; Step2: Function macro selection (00.01=2 or 3) ; Step3: Set the sensor range (15.07); Step4: Determine the feedback type of the sensor, and input the voltage feedback signal by default for AI1 and AI2, or select the input current feedback signal for AI1 through the jumper seat JP3; Step5: Set target pressure, which can be set by parameter 15.08, or by keyboard up and down keys; Step6: For details, refer to the description of water supply parameters for soft start-up of three pumps.
Three-pump cycle soft start (3 variable frequency pumps) water supply mode	00.01=3		
Water supply mode of photovoltaic pump	00.01=4	00.03=1; 00.04=10; 16.00=0; 16.04=0.00; 12.13=80.	Step1: Initialization of parameter settings (14.12=2) ; Step2: Function macro selection (00.01=4) .
Control mode of NC machine tool	00.01=5	00.02=2; 00.03=1; 00.04=3; 00.12=80.00; 00.13=80.00; 00.16=0.5; 00.17=2.0.	Step1: Initialization of parameter settings (14.12=2) ; Step2: Function macro selection (00.01=5) .
Fire patrol mode	00.01=6	00.02=0; 00.03=1; 00.16=80.00; 01.08=1; 02.03=2950; 05.00=5; 05.01=2.0; 05.03=1.25; 05.04=2.0; 05.05=5.00; 05.06=15.0; 05.07=50.00; 05.08=100.0; 10.01=120.0; 10.06=200; 10.12=180.	Step1: Initialization of parameter settings (14.12=2) ; Step2: Function macro selection (00.01=6) .
EPS power mode	00.01=7	00.02=4; 05.12=0; 05.17=100.0; 12.19=002.	Step1: Initialization of parameter settings (14.12=2) ; Step2: Function macro selection (00.01=7) .

Appendix 3: Parameter description of soft start water supply of three pump circulation

Function code	Name	Setting range	Minimum unit	Factory setting	Change
00.01	Multi-pump water supply mode selection	0: invalid 2: (1 set of frequency conversion pump +2 sets of power frequency pump) 3: Three pump circulation soft start (3 frequency conversion pumps)	1	0	×
00.03	Run command channel selection	1: terminal operation command channel	1	0	×
00.04	Main frequency source selection	8: PID control setting	1	0	×
07.00	Input terminal DI1 function	33: PID control input 58: Start/stop (manual) 59: Operation allowed 60: Interlock 1 61: Interlock 2 62: Interlock 3 63: PFC start/stop	1	58	×
07.01	Input terminal DI2 function		1	59	×
07.02	Input terminal DI3 function		1	60	×
07.03	Input terminal DI4 function		1	61	×
07.04	Input terminal DI5 function		1	62	×
07.05	Input terminal DI6 function		1	63	×
07.06	Input terminal HDI function		1	0	×
07.18	Open collector output terminal Y1 is set		59: Interlock 1 output 60: Interlock 2 Output 61: Interlock 3 Output	1	59
07.19	Open collector output terminal Y2 setting	1		60	×
07.20	Output of programmable relay R1	1		61	×
07.21	Programmable relay R2 output	1		0	×
08.00	Operation input mode of PID	0: Automatic 1: manually input through the defined multi-function terminal	1	0	×
08.01	PID given channel selection	0: number given 1: AI1 2: AI2 3: Pulse given 4: RS485 communication	1	0	○
08.02	Given the digital quantity setting	0.0~100.0%	0.1%	50.0%	○
08.03	Selection of PID feedback channel	0: AI1 1: AI2 2: AI1+ AI2 3: AI1-AI2 4: MAX {AI1, AI2} 5: MIN {AI1, AI2} 6: Pulse given 7: RS485 communication	1	0	○
08.04	Advanced characteristic setting of PID controller	LED bit: PID polarity selection 0: positive 1: negative LED ten bits: proportional adjustment characteristic 0: constant proportional integral adjustment 1: automatic variable proportion integral adjustment LED hundred bits: integral adjustment characteristic 0: when the frequency reaches the upper and lower limits, stop integral adjustment 1: when the frequency reaches the upper and lower limits, continue integral adjustment LED thousand bits: reservation	1	000	×

HV100 Series High Performance Current Vector Inverter

08.05	Proportional gain KP	0.01~100.00	0.01	1.00	○
08.06	Integration time Ti	0.01~10.00s	0.01s	0.10	○
08.07	Differential time Td	0.01~10.00s 0.0: No derivative	0.01s	0.00	○
08.08	Sampling period T	0.01~10.00s 0.00: Automatic	0.01s	0.10	○
08.09	Deviation limit	0.0~100.0%	0.1%	0.0%	○
08.10	Closed loop preset frequency	0.00 ~ upper limit frequency	0.01Hz	0.00	○
08.11	Preset frequency holding time	0.0~3600.0s	0.1s	0.0	×
08.12	Sleep mode	0: invalid 1: Sleep when feedback pressure exceeds or falls below sleep threshold 2: Sleep when feedback pressure and output frequency are stable	1	1	×
08.13	Selection of sleep shutdown mode	0: deceleration and shutdown 1: free stop	1.00	0	○
08.14	Feedback when entering sleep and setting the pressure deviation deviation limit	0.0~20.0% Note: This function parameter is only valid for the second sleep mode	0.1%	5.0%	○
08.15	Sleep threshold	0.0 ~ 200.0% Note: This threshold is the percentage of the given pressure, and this function parameter is only valid for the first sleep mode	0.1%	100.0%	○
08.16	Awakening threshold	0.0 ~ 200.0% Note: This threshold is the percentage of the given pressure	0.1%	90.0%	○
08.17	Sleep delay time	0.0~3600.0s	0.1S	100.0	○
08.18	Wake delay time	0.0~3600.0s	0.1S	5.0	○
15.00	Terminal access disconnection delay	0.0~600.0s	0.1S	0.1	○
15.01	Polling time	0.0~600.0h	0.1h	48.0	○
15.02	Lower limit frequency of reducing pump	0.0~600.00HZ	0.01HZ	0.00	×
15.05	Add pump delay time	0.0~3600.0s	0.1S	10.0	○
15.06	Reduce pump delay time	0.0~3600.0s	0.1S	10.0	○
08.24	Sleep frequency	0.00Hz~ ~ upper limit frequency	0.01HZ	0.00	×

I. Operating instructions for One inverter with two working and three-pump cycle soft start:

- One inverter with two working** means that the inverter only starts the first frequency conversion speed regulation, and the others are directly connected to the power grid.
- Three-pump cycle soft start** means that each inverter starts, and the power grid is delayed after starting; Start first shall be connected the grid first, and then the one start later shall be used for speed regulation.

II. Description of the use of external terminals and the working process of the booster pump:

- Input terminal DI1 and ~ DI6 have their functions fixed at the factory.**
When 00.01 selects 2 or 3, the input terminals DI1 ~ DI6 fix its water supply function.
- Corresponding relationship between X terminal, Y terminal and relay**
After DI3 is short-circuited with COM, it corresponds to the output of No.59 interlock 1 in 07.18 ~ 07.21, which is referred to as No.1 pump for convenience of explanation. After DI4 is shorted to COM, it corresponds to the output of No.60 interlock 2 in 07.18 ~ 07.21, which is referred to as No.2 pump for short; After DI5 is shorted to COM, it corresponds to the output of No.61 interlock 3 in 07.18 ~ 07.21, which is referred to as No.3 pump for short.

3. Differences between DI1 and DI6

DI1 and DI6 cannot be switched on at the same time. DI1 is manually controlled to start and stop, and only one pump can be started at a time. The frequency is given by AI1, and PID adjustment is not performed. DI6 controls the start and stop under the multi-pump water supply mode, and carries out PID adjustment.

4. Manually control the working process of starting and stopping the pump

After DI1 and COM are short-circuited, the order of pump starting is Start first, start trumpet together. For example, only after DI5 is connected, only the No.3 pump is turned on; if DI4 and DI5 are connected at the same time, only the No.2 pump will be turned on; if DI3, DI4 and DI5 are connected at the same time, only the No.1 pump will be started.

5. Working process of multi-pump water supply mode

After DI6 and COM are short-circuited, the order of pump startup is Start first, start smaller power ones together, and carry out PID control.

(1) When 00.01=2 (one change and two work is valid), if all three pumps are put into operation, after the system is powered on, first turn on the No.1 pump and start the No.1 variable frequency pump to work. When the working frequency of No.1 variable frequency pump reaches 50Hz, the pump adding time will be delayed (15.05). If the measured pressure does not reach the system set pressure, the No.2 power frequency pump will be switched on. When the working frequency of No.1 variable frequency pump reaches 50Hz again, the No.3 power frequency pump will be switched on if the measured pressure still does not reach the system set pressure. If the measured pressure is greater than or equal to the set pressure of the system, the working frequency of No.1 variable frequency pump drops to the lower limit frequency of pump reduction (15.02), and the No.3 power frequency pump will be disconnected after the pump reduction delay (15.06). If the measured pressure is still greater than or equal to the set pressure of the system, and the working frequency of No.1 variable frequency pump is less than or equal to the lower limit frequency of pump reduction (15.02)

(2) When 00.01=3 (three pump circulation is valid), if all three pumps are put into operation, after the system is powered on, connect pump No. 1 first and start the frequency conversion work of pump No. 1. When the No.1 pump works at 50Hz, after adding pump delay (15.05), if the measured pressure does not reach the set pressure of the system, disconnect the No.1 pump, and turn on the No.2 pump and the No.1 power frequency pump. At this time, the No.1 pump changes from frequency conversion state to power frequency state, and the No.2 pump works in frequency conversion state. When the No.2 pump works at 50Hz, after adding pump delay (15.05), if the measured pressure still fails to reach the set pressure of the system, disconnect the No.2 pump, and turn on the No.3 pump and the No.2 power frequency pump. At this time, the No.2 pump is switched from the variable frequency pump to the power frequency state, while the No.3 pump is still in the power frequency state. When the working frequency of No.3 pump drops to the lower limit frequency of pump reduction (15.02), after pump reduction delay (15.06), if the measured pressure is greater than or equal to the set pressure of the system, disconnect the No.1 power frequency pump; When the working frequency of No.3 pump is less than or equal to the lower limit frequency of pump reduction (15.02), after the pump reduction delay (15.06), if the measured pressure is still greater than or equal to the set pressure of the system, disconnect the No.2 power frequency pump; Finally, only the No.3 variable frequency pump works.

Note: All three pumps shall be put into operation if one with three are required. If you need one with two, choose two pumps at will; If you need to one with one, choose one pump to put it into operation at will; They are all in accordance with the rules of putting in first, starting first, and putting in the smaller power ones first.

6. Terminal access disconnection delay

The signal is out of sync due to the delay of the contactor terminal connection and disconnection, which requires the terminal input disconnection delay (15.00) to adjust.

7. Description of DI2 terminal

DI2 is the operation permission terminal, which is connected to the normally closed point of external fault relay, and is generally controlled by external water shortage or high voltage signal. If there is no external fault detection, it needs to be short-circuited with COM.

III. The application of STOP/RST key

1. 14.01 The factory default is 3, that is, the STOP/RST key is valid when the terminal controls the operation mode. If the keyboard is used to stop the machine, it is necessary to re-access the DI2 and DI6 terminals or re-power them on before they can work normally.

2. When 14.01=0, the STOP/RST key is invalid during terminal control, and only resets the inverter fault. In general, 14.01 is set to 0 to prevent misoperation of keyboard shutdown, and it is necessary to re-access DI2 and DI6 terminals or re-power them on before they can work normally.

III. Working process in case of failure during water supply

1. In case of external failure of the variable frequency pump, stop the failed pump first, and then switch the No.1 power frequency pump to the variable frequency pump. For example, No.1, No.2 and No.3 pumps are all turned on, while No.1 and No.3 are all power frequencies. In case of inverter failure, stop No.2 pump first, then switch No.3 power frequency to the variable frequency pump, and continue power frequency on No.1; If the external fault of No.3 pump is relieved, it can be put into use normally.

2. In case of internal failure of variable frequency pump, all pumps are stopped. After the failure of inverter is reset by keyboard, the normal working state is restored.

IV. Function setting

1. To turn on the water supply function, you need to set 00.01 as option 2 or 3. Please refer to the instructions for specific selection.
2. To start the PID function, set 00.04=8, and then set the required PID parameters in the 008 group. See the manual for details.
3. 14.01 is set to 0, that is, the keyboard stop key is invalid.

V. Wiring diagram of water supply

1、Schematic diagram of relay with open collectors Y1 and Y2:

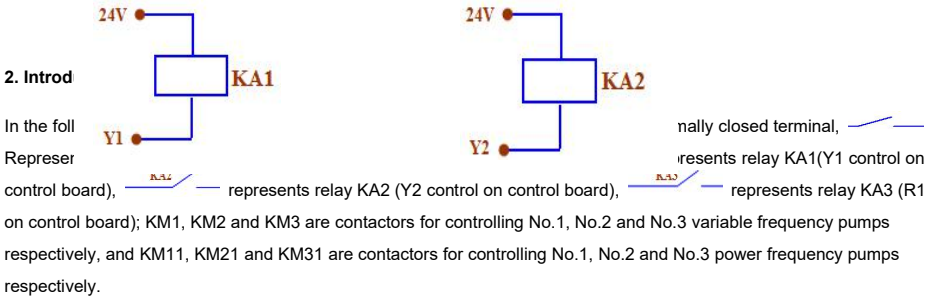

(Note: Figure 1 and Figure 2 below are only sketch logic diagrams, if you need fault relay or indicator light, add them yourself.)

3. Introduction of contactor interlocking and self-locking (as shown in Figure 1)

- KM11, KM2 and KM3 cannot be turned on when KM1 is turned on.
- KM1 cannot be switched on when KM11 is switched on.
- KM21, KM1 and KM3 cannot be connected when KM2 is connected.
- When KM21 is switched on, KM2 cannot be switched on.
- KM31, KM1 and KM2 cannot be connected when KM3 is connected.
- KM1 cannot be switched on when KM11 is switched on.

Figure 1:

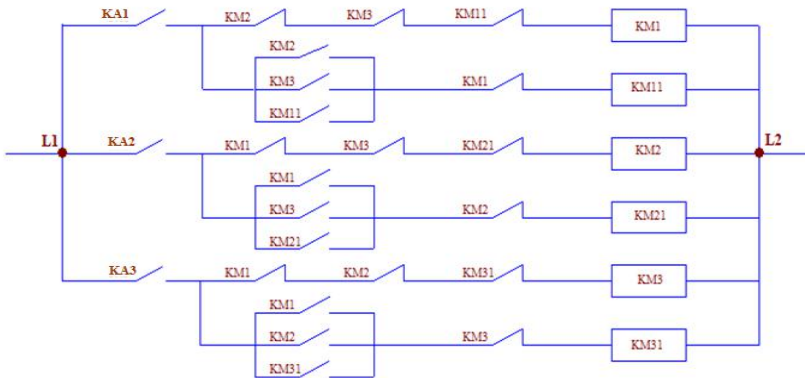
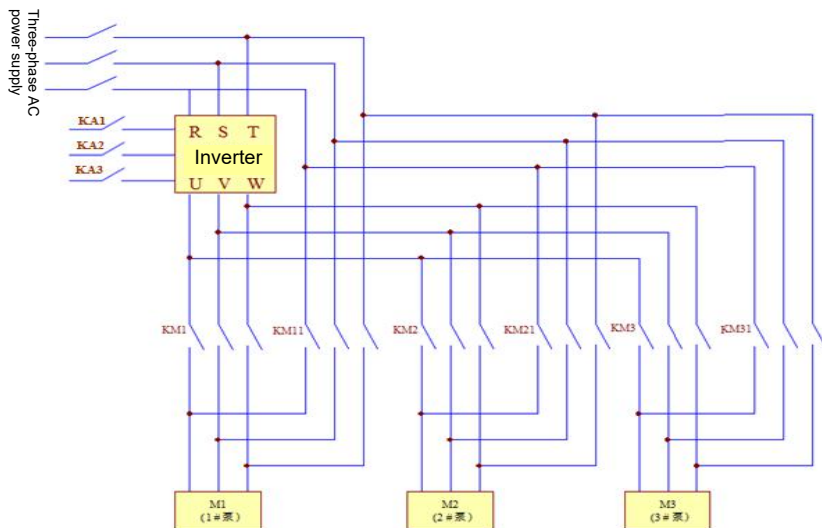

Figure 2:



Warranty agreement

- 1 The warranty period of this product is 18 months (subject to the information of fuselage bar code). During the warranty period, if the product breaks down or is damaged under normal use according to the instruction manual, our company is responsible for free maintenance.
- 2 During the warranty period, if the damage is caused by the following reasons, a certain maintenance fee will be charged:
 - A. machine damage caused by errors in use and self-repair or modification without authorization;
 - B. machine damage caused by fire, flood, abnormal voltage, other natural disasters and secondary disasters;
 - C. hardware damage caused by man-made falling and transportation after purchase;
 - D. machine damage caused by not operating in accordance with the user's manual provided by our company;
 - E failures and damages caused by obstacles other than machines (e.g. external equipment factors);
- 3 In case of product failure or damage, please fill in the contents of Product Warranty Card correctly and in detail.
4. The collection of maintenance fees shall be subject to the maintenance price list newly adjusted by our company.
- 5 This warranty card will not be reissued under normal circumstances. Please keep this card and show it to maintenance personnel during warranty.
6. If there is any problem in the service process, please contact our agent or our company in time.

Edition: V4.0

Thanks for choosing HNC product.

Any technique support, please feel free to contact our support team

Tel: 86(20)84898493 Fax: 86(20)61082610

URL: www.hncelectric.com

Email: support@hncelectric.com

